

# XV-102

## Touch display



**EATON**

*Powering Business Worldwide*

All brand and product names are trademarks or registered trademarks of the owner concerned.

### **Emergency On Call Service**

Please call your local representative:

[Eaton.eu/aftersales](https://eaton.eu/aftersales)

or

Hotline of the After Sales Service:

+49 (0) 180 5 223822 (de, en)

[AfterSalesEGBonn@eaton.com](mailto:AfterSalesEGBonn@eaton.com)

### **Original instructions**

The German-language edition of this document is the original operating manual.

1st edition 2014

see list of revisions, chapter „general“

© 2004 by Eaton Industries GmbH, 53105 Bonn

Editor: Antje Nonnen

All rights reserved, including those of the translation.

No part of this manual may be reproduced in any form (printed, photocopy, microfilm or any other process) or processed, duplicated or distributed by means of electronic systems without written permission of Eaton Industries GmbH, Bonn.

Subject to alteration without notice.

# Content

<b>1</b>	<b>General</b> .....	<b>5</b>
1.1	List of revisions .....	5
1.2	Purpose of these Operating manuals.....	5
1.3	Comments about this document .....	5
1.4	Further reading.....	6
<b>2</b>	<b>Description of device</b> .....	<b>7</b>
2.1	Function .....	7
2.2	Intended use .....	7
2.3	Device models .....	7
2.4	Package contents.....	9
2.4.1	3.5" devices .....	9
2.4.2	5.7" devices .....	10
2.4.3	7.0" devices .....	10
2.5	Accessory devices .....	10
2.6	Marking .....	11
2.7	Marine approvals.....	12
<b>3</b>	<b>Safety regulations</b> .....	<b>13</b>
3.1	Basics.....	13
3.2	Precautionary statements .....	14
3.3	Mandatory requirements, personnel requirements .....	15
3.3.1	Occupational safety.....	15
3.3.2	Personnel qualifications .....	15
3.3.3	Operating manual.....	15
3.3.4	Installation, maintenance, and disposal.....	15
3.3.5	Prohibited use .....	15
3.3.6	Prerequisites for proper operation .....	16
3.4	Device-specific hazards.....	17
<b>4</b>	<b>Operating and indication elements</b> .....	<b>21</b>
4.1	Overview.....	21
<b>5</b>	<b>Installation</b> .....	<b>23</b>
5.1	Safety regulations .....	23
5.2	Prerequisites for the location of use .....	23
5.2.1	Engineering conditions of acceptability by Underwriters Laboratories Inc. (UL) .....	23
5.2.2	Conditions for marine approval (DNV GL) .....	23
5.2.3	Requirements for the mounting position .....	24
5.3	Interfaces .....	25

## Content

5.3.1	Overview of interfaces.....	26
5.3.2	Preparation of cables with D-Sub connector.....	28
5.3.3	Power supply .....	30
5.3.4	RS232 (System Port).....	32
5.3.5	Ethernet .....	33
5.3.6	USB device .....	34
5.3.7	USB Host .....	34
5.3.8	SmartWire-DT Master .....	35
5.3.8.1	Additional documentation for devices with SmartWire-DT Master interface.....	35
5.3.8.2	Operating and indication elements of the SmartWire-DT master interface.....	36
5.3.8.3	POW/AUX (power supply for SmartWire-DT) .....	37
5.3.8.4	SWD (SmartWire-DT interface).....	38
5.3.8.5	Commissioning the SmartWire-DT network.....	39
5.3.9	CAN .....	41
5.3.10	Profibus.....	44
5.3.11	RS485 .....	47
5.4	Mounting .....	49
5.4.1	Mounting the device .....	50
5.4.2	Screening the communication cables used .....	54
<b>6</b>	<b>Operation.....</b>	<b>55</b>
6.1	Safety regulations .....	55
6.2	Starting the device .....	56
6.3	Switch off the device .....	56
6.4	Inserting and removing the SD card .....	57
<b>7</b>	<b>Maintenance and repairs.....</b>	<b>59</b>
7.1	Safety regulations .....	59
7.2	Maintenance .....	59
7.2.1	Cleaning the resistive touchscreen.....	59
7.2.2	Recalibrating the resistive touchscreen .....	59
7.2.3	Battery .....	59
7.3	Maintenance .....	60
7.3.1	Repairs.....	60
7.4	Troubleshooting .....	61
<b>8</b>	<b>Storage, transport and disposal.....</b>	<b>63</b>
8.1	Safety regulations .....	63
8.2	Storage .....	63
8.3	transport.....	63
8.4	Disposal .....	64
<b>9</b>	<b>Technical data .....</b>	<b>65</b>
9.1	Dimensions and weights .....	65

9.1.1	3.5" devices .....	65
9.1.2	5.7" devices .....	66
9.1.3	7.0" devices .....	67
9.2	Display.....	68
9.3	Touch sensor.....	68
9.4	System .....	69
9.5	Interfaces .....	70
9.5.1	Power supply .....	71
9.5.2	SmartWire-DT Master .....	72
9.5.2.1	POW/AUX (power supply interface for SmartWire-DT) .....	72
9.5.2.2	SWD (SmartWire-DT interface).....	73
9.6	IP degrees of protection on the device .....	74
9.7	Approvals and declarations .....	74
9.8	Applied standards and directives .....	75
9.9	Environmental conditions .....	76

# Content

## 1 General

### 1.1 List of revisions

The following table only lists major modifications.

Publication date	Page	Keyword	new	modified
08/2016		Marine approval for the XV-102 series	✓	
06/2018	74	Approval update		✓
07/2019	/	Device models update		✓
10/2020	/	Device models update		✓

### 1.2 Purpose of these Operating manuals

These Operating manuals contain the information required for the correct and safe use of the XV-102 touch display. The Operating manuals are part of the devices and must therefore be kept nearby.

These Operating manuals describe all aspects of the devices: transport, installation, commissioning, operation, maintenance, storage and disposal. The operating system and the application software are not described.

 **Read Chapter 3 Safety regulations, 13, before working with the device. This contains important information for your personal safety. This chapter must be read and understood by all persons working with this device.**

**⚠ WARNING**



**Incomplete operator manual copies**

Working with individual pages taken out from the operator manual may lead to bodily injury and property damage due to missing safety information.

▶ Always work with the complete document.

### 1.3 Comments about this document

Please send your comments, recommendations or suggestions about this document to [automation@eaton.com](mailto:automation@eaton.com).

## 1 General

### 1.4 Further reading

#### 1.4

#### Further reading

##### Hardware

For more information on additional devices and modules, please refer to the following documentation:

- Instructional leaflet IL048007ZU

##### Software

The following documents may also be helpful in relation to the use of this device:

- Quick Start Guideline XV100 MN04802013Z  
(commissioning the touch display, establishing communication with the programming PC and creating projects with GALILEO and XSoft-CoDeSys-2)
- System Description Windows CE MN05010007Z  
(operation of the Windows CE operating system on touch displays)

##### Communication

In order to integrate your device into your system, additional communication settings will need to be configured as appropriate for the PLC being used.

The following documents explain what needs to be taken into account and configured:

- Networks in Brief MN05010009Z  
(information on networks in general and on how to integrate PCs and touch displays in networks)
- User Manual XSOF-CODESYS 2 MN04802091Z, PLC programming
- User Manual XSOF-CODESYS 3 MN048008ZU, PLC programming

##### Tutorials

Helpful videos that explain how to use certain functions can be found on the corresponding product pages on the Internet.

- GALILEO Videos <http://www.eaton.eu/GALILEO/#tabs-4>
- EasyE4 Tutorials <http://www.eaton.eu/easy/#tabs-5>

##### SmartWire-DT

- SmartWire-DT The System Manual MN05006002Z
- SmartWire-DT Module Manual IP20 MN05006001Z
- SmartWire-DT Module Manual IP67 MN05006001Z



**Documents relevant for the devices with SmartWire-DT Master interface, see Chapter 5.3.8 SmartWire-DT Master, 35.**

##### Download Center

Click on the Customer Support tab to get to the Download Center - Documentation page  
<http://www.eaton.eu/doc>

##### Product pages

For the latest information on the product, please visit the Automation, Control & Visualization section at:  
<http://www.eaton.eu/xv>  
XV-102 as visualization of the device series easyE4: <http://www.eaton.eu/easyE4>

##### Eaton Online Catalog

<http://www.eaton.eu/ecat>

Enter "XV100" into the search box and the catalog will take you directly to the corresponding product group in the Automation, Control and visualization section.



## 2 Description of device

### 2.1 Function

Touch displays XV-102 can be used as HMI devices or as integrated HMI/PLC devices.

### 2.2 Intended use

Touch displays XV-102 are primarily intended for use in machine and system building applications. They are intended exclusively for monitoring, operating, and controlling machines and systems. Any other use must be discussed and agreed upon with the manufacturer in advance.

### 2.3 Device models



Fig.. 1 XV-102 3.5"



Fig.. 2 XV-102 5.7"



Fig.. 3 XV-102 7,0"

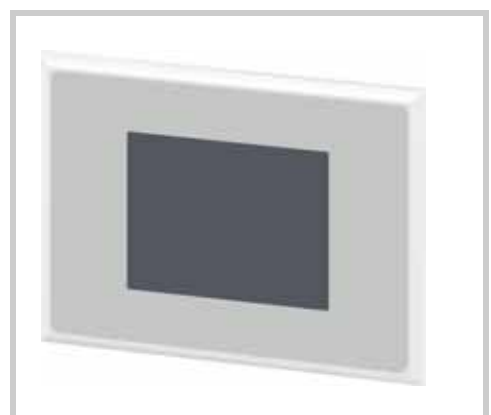

Fig.. 4 XV-102 design for easyE4

The following versions of touch displays XV-102 are available:

## 2 Description of device

### 2.3 Device models

Basic features	Display	Communication interfaces	XV-102 part no.
Version A: ■ 1 Slot for 1 SD-card ■ Integrated interfaces: 1 × Ethernet 100/10 1 × USB Device Communication interfaces	Resistive touch, 3.5" TFT-LCD, 32 gray levels, QVGA	–	XV-102-A0-35MQR...
		Profibus	XV-102-A2-35MQR...
		RS232	XV-102-A3-35MQR...
		RS485	XV-102-A4-35MQR...
		CAN and RS232	XV-102-A5-35MQR...
Version B: ■ 1 Slot for 1 SD-card ■ Integrated interfaces: 1 × Ethernet 100/10 1 × USB Device Communication interfaces	Resistive touch, 3.5" TFT-LCD, 32 gray levels, QVGA	–	XV-102-B0-35MQR...
		RS232	XV-102-B3-35MQR...
		RS485	XV-102-B4-35MQR...
		CAN and RS232	XV-102-B5-35MQR...
		CAN and RS485	XV-102-B6-35MQR...
Version D: ■ 1 Slot for 1 SD-card ■ Integrated interfaces: 1 × Ethernet 100/10 1 × USB Device 1 × USB host Communication interfaces	Resistive touch, 5.7" TFT-LCD, 64K colors, VGA	–	XV-102-B0-35TQR...
		Profibus	XV-102-B2-35TQR...
		RS232	XV-102-B3-35TQR...
		RS485	XV-102-B4-35TQR...
		CAN and RS232	XV-102-B5-35TQR...
		CAN and RS485	XV-102-B6-35TQR...
		Profibus and RS485	XV-102-B8-35TQR...
		SmartWire-DT Master	XV-102-BE-35TQR...
		RS232	XV-102-D0-57TVR...
		RS485 and RS232	XV-102-D4-57TVR...
CAN, RS485 and RS232	XV-102-D6-57TVR...		
Profibus, RS485 and RS232	XV-102-D8-57TVR...		
Version D: ■ 1 Slot for 1 SD-card ■ Integrated interfaces: 1 × Ethernet 100/10 1 × USB Device 1 × USB host Communication interfaces	Resistive touch, 7.0" TFT-LCD, 64K colors, WVGA	RS232	XV-102-D0-70TWR...
		RS485 and RS232	XV-102-D4-70TWR...
		CAN, RS485 and RS232	XV-102-D6-70TWR...
		Profibus, RS485 and RS232	XV-102-D8-70TWR...

Basic features	Display	Communication interfaces	XV-102 part no.
Version E:	Resistive touch, 5.7" TFT-LCD, 64K colors, VGA	CAN, RS485 and SmartWire-DT master	XV-102-E6-57TVR...
■ 1 Slot for 1 SD-card		Profibus, RS485 and SmartWire-DT master	XV-102-E8-57TVR...
■ Integrated interfaces:	Resistive touch, 7.0" TFT-LCD, 64K colors, WVGA	CAN, RS485 and SmartWire-DT master	XV-102-E6-70TWR...
1 × Ethernet 100/10		Profibus, RS485 and SmartWire-DT master	XV-102-E8-70TWR...
1 × USB Device			
1 × USB host			
Communication interfaces			
Version H:	Resistive touch, 3.5" TFT-LCD, 64K colors, QVGA	RS232	XV-102-H3-35TQR...
■ 1 Slot for 1 SD-card		RS485	XV-102-H4-35TQR...
■ Integrated interfaces:	Resistive touch, 5.7" TFT-LCD, 64K colors, VGA	RS232	XV-102-H3-57TVR...
1 × Ethernet 100/10		RS485	XV-102-H4-57TVR...
1 × USB Device			
1 × USB-Host (only 5.7" and 7.0" devices)			
Communication interfaces	Resistive touch, 7.0" TFT-LCD, 64K colors, WVGA	RS232	XV-102-H3-70TWR...
		RS485	XV-102-H4-70TWR...

Tab. 1 Device models

## 2.4

### Package contents



If necessary, you can order stylus pens in groups of ten (ACCESSORIES-TP-PEN-10, article no. 139808), as well as other accessories. Please contact the supplier.

The accessories supplied with the XV-102 touch display depend on the size of the device.

### 2.4.1

#### 3.5" devices

Number	Description
1	Touch display: ■ XV-102-...-35MQR... or ■ XV-102-...-35TQR...
4	Mounting brackets with grub screw for flush mounting
1	Sealing strip for mounting the device (glued in the device and/or loose enclosed)
1	Power supply connector for the device
1	Power supply connector for SmartWire-DT Master (only supplied with XV-102-BE-...- devices)

Tab. 2 Package contents for 3.5" devices

## 2 Description of device

### 2.5 Accessory devices

#### 2.4.2

#### 5.7" devices

Number	Description
1	Touch display: ■ XV-102-...-57TVR...
6	Mounting brackets with grub screw for flush mounting
1	Sealing strip for mounting the device (glued in the device and/or loose enclosed)
1	Power supply connector for the device
1	Power supply connector for SmartWire-DT Master (only supplied with XV-102-E...- devices)

Tab. 3 Package contents for 5.7" devices

#### 2.4.3

#### 7.0" devices

Number	Description
1	Touch display: ■ XV-102-...-70TWR...
8	Mounting brackets with grub screw for flush mounting
1	Sealing strip for mounting the device (glued in the device and/or loose enclosed)
1	Power supply connector for the device
1	Power supply connector for SmartWire-DT Master (only supplied with XV-102-E...- devices)

Tab. 4 Package contents for 7.0" devices

### 2.5

#### Accessory devices

Different accessories are available. Only use original accessories.



**Order the accessories required from your supplier.**

## 2.6

### Marking

#### Nameplate

The device has a nameplate on rear. This nameplate makes it possible to identify the device and includes the following information:

- Manufacturer address
- Part no.
- Power supply required
- Article No. (part No. or article No.)
- Serial No.
- Date of manufacture (week/year)
- Certification marks and information concerning the corresponding certifications/approvals
- Layout of ports/interfaces and controls
- Permissible mounting options (top edge «Top»)

#### Support

To get fast and effective support, make sure to always provide Customer Service with the following information from the nameplate:

- Article No. (part No. or article No.)
- Serial No.

## 2 Description of device

### 2.7 Marine approvals

#### 2.7

#### Marine approvals

##### Obtained type approvals

The touch displays **HMI/PLC XV-102** have been granted the required shipping classification by Det Norsk Veritas / Germanischer Lloyd (DNV GL)

- DNVGL-CG-0339 type approval, November 2015 edition,  
"Environmental test specification for electrical, electronic and programmable equipment and systems"  
Certificate No.: TAA00000NC

##### Location classes

Temperature	B - Ambient air temperature: 0°C to +55°C
Humidity	B - Relative humidity up to 100 % at all relevant temperatures.
Vibration	A - Bulkheads, beams, deck, bridge, Acceleration amplitude: 0.7 g
EMC	B* - All locations (including bridge and open deck)
Input	Required protection according to DNV-GL Rules shall be provided upon installation on board

\* Filters / Ferrites maybe required to fulfil. See installation restrictions

##### Installation restrictions

- Installation and commissioning as indicated in the documentation for the touch display
- Screened communication cables improve EMC behavior
- PE connection of communication cables improve EMC behavior  
(e.g. earth-connection kit: EATON ZB4-102-KS1)

Location class	interface	Installation
EMC B	Power supply	Place interference filter
	Ethernet	Place the ferrite core or snap-together ferrites at a max. distance of 20 cm from the external device plug.
	SWD communication	
	SWD power supply	
	RS485	
	RS232	



5.2.2 Conditions for marine approval (DNV GL), 23

5.3.3 Section Radio interference suppression filter for the 24 V DC supply,  
 31

5.4.2 Screening the communication cables used, 54



## 3 Safety regulations

### 3.1 Basics

The device has been designed according to the state of the art and all generally accepted safety rules and standards. However, this alone cannot eliminate all potential hazards, which is why it is necessary for you to be aware of all hazards and residual risks.

Do not run the device unless it is in perfect technical condition. Make sure to always operate it as specified in this document.



**Read this chapter before working with the device. This contains important information for your personal safety. This chapter must be read and understood by all persons working with this device.**



### 3 Safety regulations



#### 3.2 Precautionary statements



#### 3.2

#### Precautionary statements

The following symbols are used in this document according to the hazard level described:

 <b>DANGER</b>	
	<b>DANGER signal word</b> Indicates an imminent hazardous situation that will result in death or serious injury if it is not avoided.

 <b>WARNING</b>	
	<b>WARNING signal word</b> Indicates a potentially hazardous situation that could result in death or serious injury if it is not avoided.

 <b>CAUTION</b>	
	<b>CAUTION signal word</b> Indicates a potentially hazardous situation that could result in minor or moderate injury if it is not avoided.

<b>CAUTION</b>	
	<b>CAUTION signal word without warning sign</b> Indicates a situation that could result in property damage if it is not avoided.

 **Used to highlight useful information.**

The hazard symbol used and the corresponding text will provide information regarding the specific hazard and how to avoid or prevent it.



### 3.3 Mandatory requirements, personnel requirements

#### 3.3.1 Occupational safety



All generally accepted occupational health and safety rules and standards (internal and national) must be complied with.

#### 3.3.2 Personnel qualifications

The personnel responsible for installation, operation, maintenance, and repairs must have the necessary qualifications for the work they will be performing. They must be appropriately trained and/or briefed and be informed of all hazards and risks associated with the device.

#### 3.3.3 Operating manual

It must be ensured that any person working with the device in any phase of its lifespan has read and understood the relevant sections of the Operating manuals.

 <b>WARNING</b>	
	<p><b>Incomplete operator manual copies</b></p> <p>Working with individual pages taken out from the operator manual may lead to bodily injury and property damage due to missing safety information.</p> <p>▶ Always work with the complete document.</p>

#### 3.3.4 Installation, maintenance, and disposal

Make sure that the device is connected, installed, serviced, and disposed of professionally and in line with all relevant standards and safety rules.

#### 3.3.5 Prohibited use

The implementation of safety functions (relating to the protection of personnel and machinery) using the device is prohibited.

## 3 Safety regulations

### 3.3 Mandatory requirements, personnel requirements

#### 3.3.6

#### Prerequisites for proper operation

In order for the device to be able to meet the contractually stipulated terms, the following must be observed:

- Only qualified personnel should be allowed to work with the device.
- These persons must have read the Operating manuals and must observe the requirements described.
- The ambient conditions stated must be observed. See chapter 9.9 Environmental conditions, 76
- Maintenance work must be carried out correctly.
- Potentially explosive atmosphere, Zone 22:  
The ground resistance of accessible metal parts must be less than  $10^9$  ohms.

We assume no liability for damages, consequential damages, and/or accidents caused by the following:





- Failure to follow occupational health and safety rules and standards
- Device failures or function disturbances
- Improper use and/or handling
- Failure to observe the Operating manuals
- Alterations, changes, and repairs to the device



**Repairs, see Chapter 7.3.1 Repairs, 60.**

## 3.4

### Device-specific hazards

<b>⚠ DANGER</b>	
	<p><b>Explosion hazard</b></p> <p>Death, serious injury, and property damage may occur if the device is being used in a potentially explosive (classified) location and, during operation, an electrical plug-in connection is disconnected or the device is exposed to dangerous impacts or other types of dangerous mechanical shock.</p> <ul style="list-style-type: none"><li>▶ Use the device in the following environments only:<ul style="list-style-type: none"><li>- Non-hazardous (non-explosive) areas</li><li>- Potentially explosive atmosphere, Zone 22 (according to ATEX 94/9/EC)</li></ul></li><li>▶ Potentially explosive atmosphere, Zone 22: The ground resistance of accessible metal parts must be less than <math>10^9</math> ohms.</li><li>▶ When used in a potentially explosive atmosphere, Zone 22, the environment has to be designed to avoid any bunch discharge</li><li>▶ Make sure that the device is not exposed to dangerous impacts and other types of dangerous mechanical shock.</li><li>▶ Do not operate the device in hazardous (classified) locations unless it is mounted correctly.</li><li>▶ De-energize the device before disconnecting plug connections.</li></ul>
<b>⚠ WARNING</b>	
	<p><b>Live parts inside the device</b></p> <p>When the device is open, there will be an electric shock hazard if live parts are touched.</p> <ul style="list-style-type: none"><li>▶ The device must not be opened.</li></ul>
<b>⚠ WARNING</b>	
	<p><b>Stray currents</b></p> <p>Large transient currents between the protective circuits of different devices may result in fire or in malfunctions due to signal interference.</p> <ul style="list-style-type: none"><li>▶ If necessary, a potential equalization conductor should be installed parallel to the cable. This should have a cross-section that is a multiple of the cable screen.</li></ul>
<b>⚠ CAUTION</b>	
	<p><b>Electrostatic discharge</b></p> <p>Electrostatic discharge may damage or destroy electronic components.</p> <ul style="list-style-type: none"><li>▶ Avoid contact with components (such as connector pins) that are susceptible to electrostatic discharge.</li><li>▶ Discharge (by touching a grounded metal object) any static charge accumulated in your body before touching the device.</li></ul>

## 3 Safety regulations

### 3.4 Device-specific hazards

#### CAUTION



##### Non-galvanically-isolated interfaces

The device may be damaged by potential differences.

- ▶ The GND terminals of all bus modules must be connected.

#### CAUTION



##### Sensitive resistive touch surface

Damage to the resistive touch due to the use of pointed or sharp objects.

- ▶ Only activate the resistive touch with your finger or a stylus.
- ▶ When wearing gloves, ensure that these are clean. They must not be covered with abrasive dust or sharp particles.

#### CAUTION



##### Data loss

During a write operation, the SD card may lose data or may be destroyed if it is removed or if there is a power failure.

- ▶ Insert the SD card only when the device is de-energized.
- ▶ Avoid writing to SD cards as much as possible. Reasons:
  - SD cards have a limited number of write cycles.
  - If there is a voltage drop while a write operation is in progress, data loss is highly likely to occur.
- ▶ Remove the SD card only when the device is de-energized.
- ▶ Before switching off, ensure that no software write operations to the SD card are in progress.

#### CAUTION



##### Condensation in/on the device

If the device is or was exposed to climatic changes (temperature fluctuation, air humidity) moisture can form on or in the device (device condensation). In this case, there is a risk of short-circuit.

- ▶ The device must **not** be switched on when device condensation is present.
- ▶ If the device has condensation in or on it, or if the device has been exposed to temperature fluctuations, let the device settle into the existing ambient air temperature before switching it on (do not expose the device to direct thermal radiation from heating appliances).

**CAUTION**



**UV light**

When exposed to UV light, plastics can embrittle and the lifespan of the device is reduced.

- ▶ Protect the device against direct sunlight and lamps with UV rays.

**CAUTION**



**Cleaning the device**

Damage to the device due to the use of pointed or sharp objects or by liquids.

- ▶ Do not use any pointy or sharp objects (e.g., knives) to clean the device.
- ▶ Do not use aggressive or abrasive cleaning products or solvents.
- ▶ Prevent liquids from getting into the device (short-circuit hazard).

### 3 Safety regulations

#### 3.4 Device-specific hazards

## 4 Operating and indication elements

### 4.1 Overview



Fig.. 5 Example Operating and indication elements of the 3.5" devices

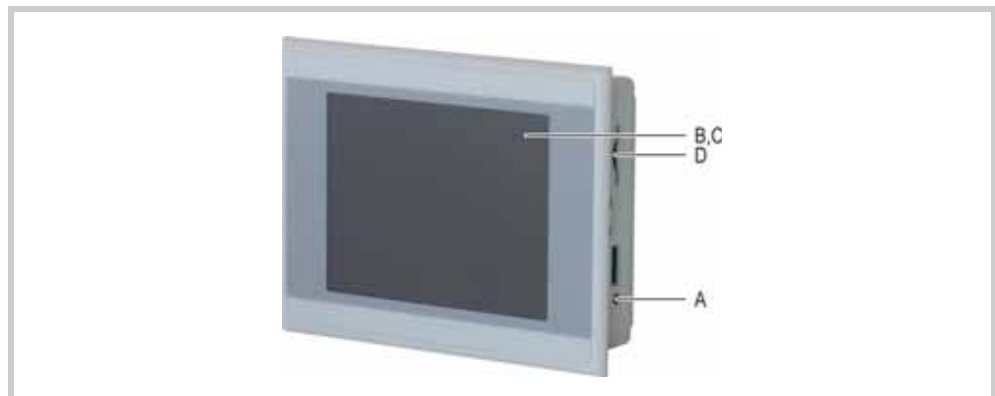

Fig.. 6 Operating and indication elements of the 5.7" and 7.0" devices

The device has the following operating and indication elements:

Element	Function
A Control button	Function depends on the software used.
B Display	Display operating and indication elements.
C Touch sensor	Resistive touch: Detection of the actuation of the operating elements shown on the display. These devices are operated by touching the operating elements with your finger or with a stylus.
D SD slot 0	Slot for SD card.

Tab. 5 Operating and indication elements

## 4 Operating and indication elements

### 4.1 Overview



## 5 Installation

### 5.1 Safety regulations

 **Read Chapter 3 Safety regulations, 13 before installing and commissioning the device. This contains important information for your personal safety.**

### 5.2 Prerequisites for the location of use

- Approvals:  
The device must be used exclusively in locations for which it has been approved/certified. See the markings on the nameplate and Chapter 9 Technical data, 65.
- Power supply:  
The power supply must comply with the requirements stated in Chapter 9.5.1 Power supply, 71.

#### 5.2.1 Engineering conditions of acceptability by Underwriters Laboratories Inc. (UL)

For the approval in accordance with the standard UL 508, consideration must be given to the following:

- Ambient conditions:
  - Max. ambient air temperature: 50°C
  - Degree of pollution 2
- The screw terminals of the connector for the power supply must be tightened with a max. tightening torque of 0.6...0.8 Nm or 5...7 Lb. In.
- Only XV-102-BE-...- and XV-102-E... devices:  
The SmartWire-DT master interface's  $U_{Aux}$  supply voltage must be externally protected against overcurrent and short-circuits with the following:
  - Miniature circuit-breaker 24 VDC, rated operational current 2 A, tripping characteristic Z
  - Or a 2 A fuse

#### 5.2.2 Conditions for marine approval (DNV GL)

The following DNV GL rules for shipping classification in accordance with DNVGL-CG-0339 type approvals must be observed:

- 1 Complete and proper installation and commissioning in accordance with DNV GL rules and Eaton requirements and specifications.
- 2 Installation of radio interference suppression filters for the 24 V DC supply.
- 3 Screening the communication cables used.

 2.7 Marine approvals, 12  
5.3.3 Section Radio interference suppression filter for the 24 V DC supply, 31  
5.4.2 Screening the communication cables used, 54

## 5 Installation

### 5.2 Prerequisites for the location of use

#### 5.2.3

#### Requirements for the mounting position

The device is designed for mounting in control cabinets, control panels or control desks. It can be mounted horizontally or vertically. The following requirements must be fulfilled when selecting a suitable mounting position:

- The device should not be exposed to direct sunlight (when exposed to UV light, plastic parts of the device can embrittle and the lifespan of the device is reduced).
- If the device is to be used in potentially explosive atmospheres, the device must not be subjected to hazardous knocks.
- The inclination angle for vertical mounting without forced ventilation must be max.  $\pm 45^\circ$ .
- The operating elements on the service side of the device and the cable connections are accessible after the device has been mounted.
- The ambient conditions stated must be observed.  
See chapter 9.9 Environmental conditions, 76.
- Sufficient ventilation (cooling) must be ensured by means of:
  - Clearance of at least 3 cm to the ventilation slots
  - Clearance of at least 15 cm from heat radiating components such as heavily loaded transformers
  - The expected temperatures should be within the permissible range.  
See chapter 9.9 Environmental conditions, 76.
- Mounting surface characteristics:
  - Material thickness at the mounting cutout 2...5 mm
  - Flatness  $\leq 0.5$  mm  
(this requirement must also be fulfilled when the device is mounted!)
  - Surface roughness  $R_z \leq 120$

5.3

Interfaces

**⚠ WARNING**

 **Stray currents**

Large transient currents between the protective circuits of different devices may result in fire or in malfunctions due to signal interference.

- ▶ If necessary, a potential equalization conductor should be installed parallel to the cable. This should have a cross-section that is a multiple of the cable screen.

**⚠ CAUTION**

 **Interference**

The values specified in the technical data and the device's electromagnetic compatibility (EMC) cannot be guaranteed if unsuitable cables, improperly assembled and terminated cables, and/or unprofessional wiring are used.

- ▶ Only use cables prefabricated and terminated by professionals.
- ▶ The cables being used must be assembled and terminated as required by the port/interface description in this document.
- ▶ When wiring the device, follow all instructions regarding how to wire the corresponding port/interface.
- ▶ All general Directives and standards must be complied with.

**⚠ CAUTION**

 **Non-galvanically-isolated interfaces**

The device may be damaged by potential differences.



- ▶ The GND terminals of all bus modules must be connected.

## 5 Installation

### 5.3 Interfaces

#### 5.3.1

#### Overview of interfaces

 The interfaces will vary depending upon the device version. See nameplate and Chapter 2.3 Device models,  7.

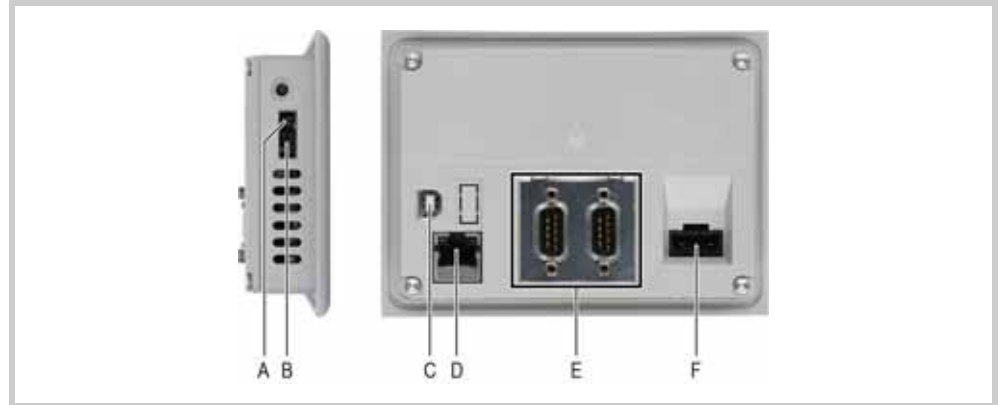

Fig.. 7 Example Interfaces of the 3.5" devices without Smart WireDT master

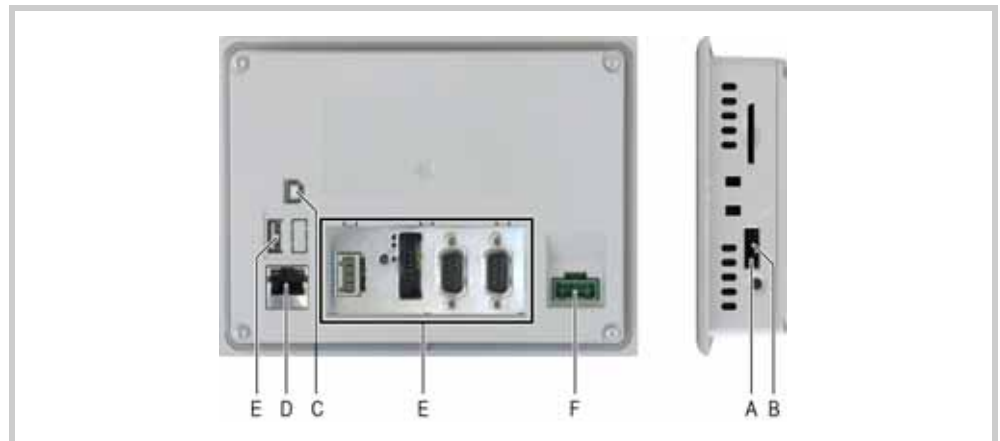

Fig.. 8 Example Interface of the 5.7" and 7.0" devices with Smart WireDT master

<b>Interface</b>	<b>Interface description</b>
A UPD/RUN jumper	Only for service tasks
B DIAG	Only for service tasks
C USB Device	→ Chapter 5.3.6, 34
D Ethernet	→ Chapter 5.3.5, 33
E Interfaces, depending on the device version:	
USB Host	→ Chapter 5.3.7, 34
SmartWire-DT Master	→ Chapter 5.3.8, 35
CAN	→ Chapter 5.3.9, 41
Profibus	→ Chapter 5.3.10, 44
RS232 (System Port)	→ Chapter 5.3.4, 32
RS485	→ Chapter 5.3.11, 47
F Power supply	→ Chapter 5.3.3, 30

Tab. 6 Overview of interfaces

## 5 Installation

### 5.3 Interfaces

#### 5.3.2

#### Preparation of cables with D-Sub connector

The design of the bus cabling is an essential factor for reliable operation and electromagnetic compatibility (EMC).

#### Wiring requirements

- The cables must be screened.
- The cable screen must consist of a copper braid.
- The cable screen must be terminated to the connector shell with a low-impedance bond across a large area. This is achieved by:
  - Using metal or metallized connector housings with a strap for strain relief.
  - The strap must be screw fastened with the connector.

#### Connecting the cable screen

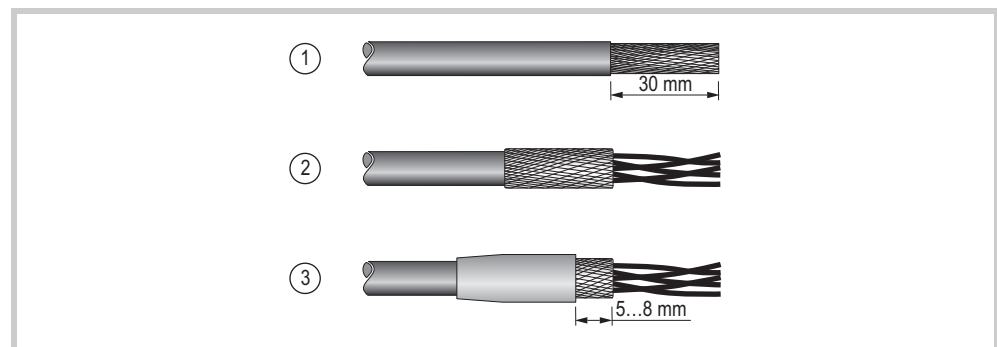

Fig.. 9 Connecting the cable screen

- 1 Insulate the cable end so that approx. 3 cm of screen braid is exposed.
- 2 Fold back the screen braid over the cable sheath.
- 3 Attach heat-shrink tubing approx. 3 cm in length over the folded screen braid or use a rubber grommet.
  - 5...8 mm of the screen braid must be exposed at the cable end.
  - The folded screen braid end must be covered by the heat-shrink tubing or the rubber grommet.
- 4 Fit the D-Sub connector to the cable end:
  - The exposed metal screen braid must be clamped to the connector casing with the cable clamp.

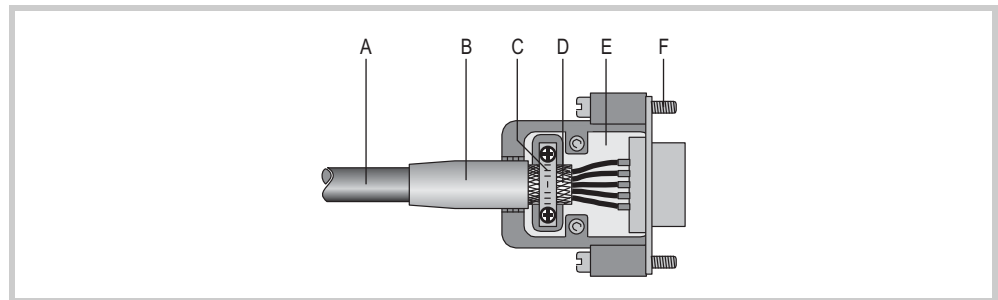

Fig.. 10 Cable prepared with D-Sub connector

- |   |                                      |   |                  |
|---|--------------------------------------|---|------------------|
| A | Cable with cable sheath              | D | Screen braid     |
| B | Heat-shrink tubing or rubber grommet | E | D-sub plug       |
| C | Strap                                | F | Fixing screw UNC |



**The EMC values stated in the technical data (immunity and emission) can only be guaranteed by observing the prescribed cable preparation!**

## 5 Installation

### 5.3 Interfaces

#### 5.3.3

#### Power supply

The device has an internal fuse and protection against polarity reversal. The functional earth is connected to the connector cover only, and not to 0 V. The housing is made of plastic and is potential-free. The device's power supply is **not** galvanically isolated.

The device requires a power supply of 24 V DC from an AC/DC transformer with safe isolation (SELV). Additional properties of the required power supply, see chapter 9.5.1 Power supply, 71.

- SELV (safety extra low voltage):  
Circuit in which no dangerous voltage is present, even in the event of a single fault.

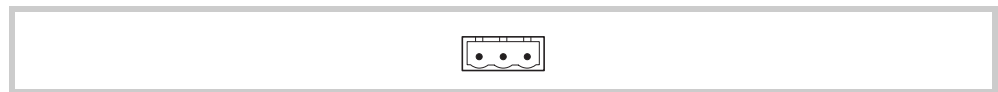

Fig.. 11 Power supply interface

#### Wiring

- Plug connector Phoenix Contact MSTB 2.5/3-ST-5.08, Phoenix Art no. 1757022 is supplied with the device.

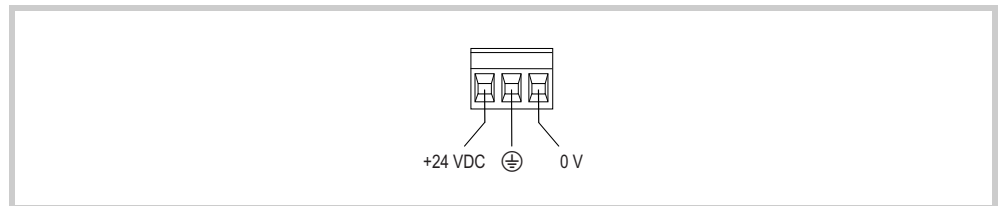

Fig.. 12 Phoenix Contact MSTB 2.5/3-ST-5.08 plug connector (view from wiring side)

Connection	Configuration
+24 VDC	Supply voltage +24 VDC
⊕	Functional earth with connector panel. Does not have to be connected. If required due to the installation environment, this connection can be used as a protective earth connection.
0 V	Supply voltage 0 V

Tab. 7 Plug connection configuration

- Observe the following when preparing the wiring of the plug connector:

#### Terminating the wiring with the plug connector

Terminal type:	Screw terminal plug-in
Cross section	<ul style="list-style-type: none"> <li>■ min. 0.75 mm<sup>2</sup> / max. 2.5 mm<sup>2</sup> (drain wire or conductor)</li> <li>■ min. AWG18 / max. AWG12</li> </ul>
Strip length	7 mm
Max. tightening torque	0.6...0.8 Nm / 5...7 Lb. In.

Tab. 8 Terminating the wiring with the plug connector



**Radio interference suppression filter for the 24 V DC supply**

Additional interference filters must be installed for the power supply in order to adhere to the EMC B provisions.

- ▶ Integrate a radio interference suppression filter into the wiring.

Depending on the output, the following filters can be used:

- XT-FIL-1 radio interference suppression filter for 24 V DC supply up to 2.2 A (Eaton article no. 285316)
- or
- XT-FIL-2 radio interference suppression filter for 24 V DC supply up to 12 A (Eaton article no. 118980)

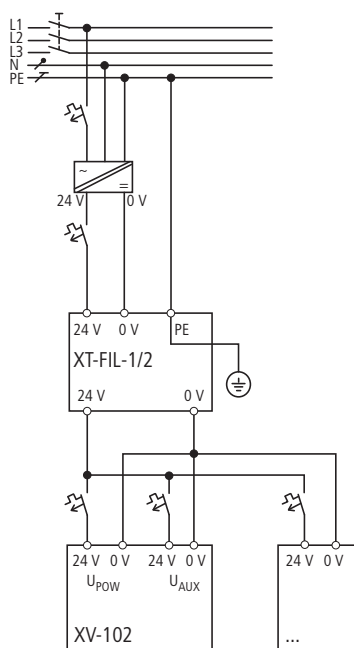

Fig.. 13 Power supply with EMC filter

Grounding is ensured either by using

- the filter's integrated contact fields onto a grounded metal plate

or using

- a separate line to the filter's PE connection.

Depending on the current consumption or configuration, several filters may be used as well.

- ☞ 2.7 Marine approvals, 12
- 5.2.2 Conditions for marine approval (DNV GL), 23
- 5.4.2 Screening the communication cables used, 54

## 5 Installation

### 5.3 Interfaces

#### 5.3.4

#### RS232 (System Port)

The RS232 interface is **not** galvanically isolated.

CAUTION	
	<p><b>Non-galvanically-isolated interfaces</b></p> <p>The device may be damaged by potential differences.</p> <p>▶ The GND terminals of all bus modules must be connected.</p>

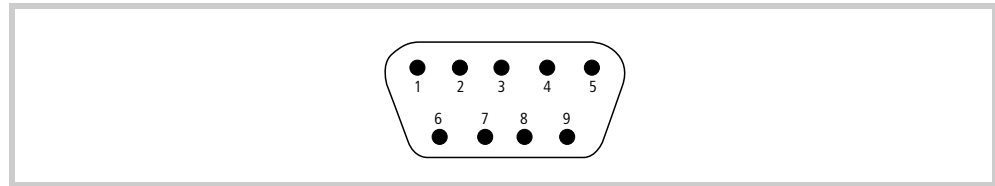

Fig.. 14 RS232 interface (9-pin, D-Sub, male, UNC)

Pin	Signal	Configuration
1	DCD	Data Carrier Detected
2	RxD	Receive Data
3	TxD	Transmit Data
4	DTR	Data Terminal Ready
5	GND	Ground
6	DSR	Data Set Ready
7	RTS	Request to Send
8	CTS	Clear To Send
9	RI	Ring Indicator

Tab. 9 Pin assignment of the RS232 interface

#### Wiring

- Screened cables must be used.
- The maximal baud rate depends on the cable length

Cable length	Max. baud rate
2.5 m	115200 bit/s
5 m	57600 Bit/s
10 m	38400 Bit/s
15 m	19200 Bit/s
30 m	9600 Bit/s

Tab. 10 Relationship of cable length / baud rate

 **When preparing the cables, ensure that there is a low-resistance connection between the cable screen and the connector casing (→ Chapter 5.3.2, 28).**

5.3.5

Ethernet

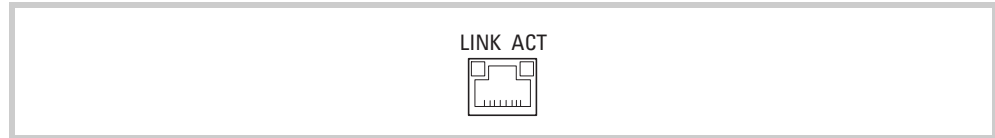

Fig.. 15 Ethernet interface (RJ45 socket)

LED	Signal	Meaning
ACT (yellow)	flashes	Ethernet is active (data traffic)
LINK (green)	lit	Active network is connected and detected

Tab. 11 Control LEDs of the Ethernet interface

Cable

- Use screened twisted pair cable (STP) for networking:
  - For device to device connection (crossover cable)
  - For connecting to the hub/switch: 1:1 patch cable
- Maximum cable length: 100 m.

**CAUTION**

**Forces on the Ethernet interface**

Communications may be affected, and the connection's mechanical components may be damaged, if the Ethernet interface is subjected to strong vibrations or the RJ45 plug-in connection is subjected to pulling.

- ▶ Protect the RJ45 plug-in connection from strong vibrations.
- ▶ Protect the RJ45 plug-in connection from tensile forces at the socket.

Eaton recommends implementing measures for protecting against cyberattacks.

**Eaton cyber security**  
<http://www.eaton.com/us/en-us/company/news-insight-s/cybersecurity.html>  
<http://www.eaton.com/cybersecurity>

## 5 Installation

### 5.3 Interfaces

#### 5.3.6

#### USB device

The USB Host interface supports USB 2.0.



Fig.. 16 USB Host interface (USB Host, type B)

#### Cable

- Only use standard USB cables with a screen.
- Maximum cable length: 5 m.

#### 5.3.7

#### USB Host

The USB Host interface supports USB 2.0.

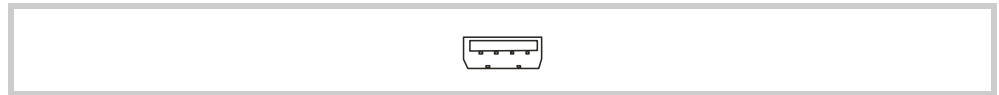

Fig.. 17 USB Host interface (USB Host, type A)

#### Cable

- Only use standard USB cables with a screen.
- Maximum cable length: 5 m.

### 5.3.8

#### SmartWire-DT Master

The SmartWire-DT Master interface is **not** galvanically isolated.

CAUTION	
	<p><b>Not galvanically isolated SmartWire-DT system</b></p> <p>The device may be damaged by potential differences.</p> <p>▶ Provide a common star point for the earth wiring.</p>

### 5.3.8.1

#### Additional documentation for devices with SmartWire-DT Master interface

In addition to this document, the following documents are required to build a SmartWire-DT network, to install the network at the SmartWire-DT Master interface and to operate the network:

- MN05006002Z SmartWire-DT The System Manual  
(System description, engineering, installation, commissioning, and diagnostics for a SmartWire-DT network)
- MN05006001Z SmartWire-DT Module Manual IP20  
(surface mounting, engineering, installation, etc. for the individual SmartWire-DT modules)
- MN120006 SmartWire-DT Module Manual IP67  
(surface mounting, engineering, installation, etc. of the single SmartWire-DT slaves, I/O modules IP67)
- MN04802091Z User Manual XSoft-CODESYS: PLC programming XV100  
(Use of the PLC programming tool XSoft-CoDeSys-2 and the PLC runtime system for the XV100 device type with Windows CE)

The documents can be downloaded from:

- [www.eaton.eu/doc](http://www.eaton.eu/doc) (search for the document number using the search field on the home page)
- [www.eaton.com](http://www.eaton.com) (search for the document number using the search field on the home page)
- [www.eaton.eu/swd](http://www.eaton.eu/swd)

## 5 Installation

### 5.3 Interfaces

#### 5.3.8.2

#### Operating and indication elements of the SmartWire-DT master interface

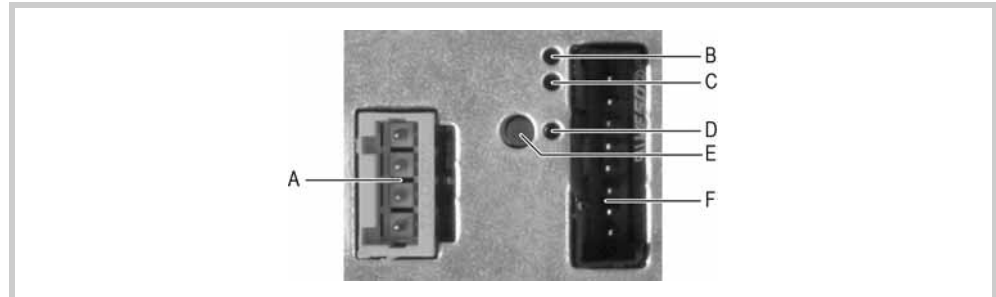





Fig.. 18 SmartWire-DT master interface

Element	Function
A POW/AUX interface	Power supply interface for SmartWire-DT (→ Chapter 5.3.8.3,  37)
B POW-LED	Lit if the SmartWire-DT network is supplied with current.
C SWD-LED	Indicates whether the physical configuration of the SmartWire-DT network matches the target configuration stored in the device. The configurations are compared every time the power supply is switched on (→ Chapter 5.3.8.5,  39).
D Config-LED	Indicates whether the SmartWire-DT master project configuration defined in the PLC matches the SmartWire-DT network target configuration stored in the device. The configurations are compared every time the power supply is switched on (→ Chapter 5.3.8.5,  39).
E Configuration button	Configure SmartWire-DT network.
F SWD Interface	SmartWire-DT interface (→ Chapter 5.3.8.4,  38)

Tab. 12 Operating and indication elements of the SmartWire-DT master interface

5.3.8.3

**POW/AUX (power supply for SmartWire-DT)**

The POW/AUX interface is **not** galvanically isolated.

The following power supplies are required for a SmartWire-DT network:

- Supply voltage POW:  
The device supply voltage for the electronics of the downstream SmartWire-DT slaves (15 VDC) is generated from the 24 V DC supply voltage applied to the POW connection.
- Supply voltage AUX:  
If there are any contactors or motor starters in the SmartWire-DT topology, a 24 V DC voltage AUX must be additionally supplied as a control voltage for the contactor coils.

Additional properties of the required power supply, see chapter 9.5.2 SmartWire-DT Master, 72.

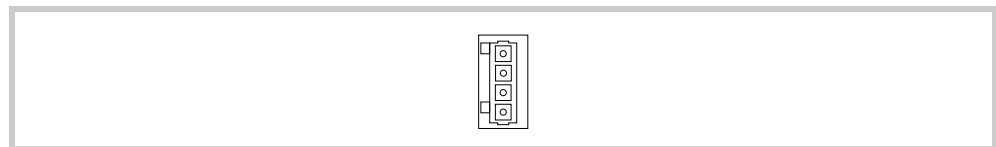

Fig.. 19 POW/AUX power supply interface

**Wiring**

- WAGO plug connector, Art no. 734-104 is supplied with the device.

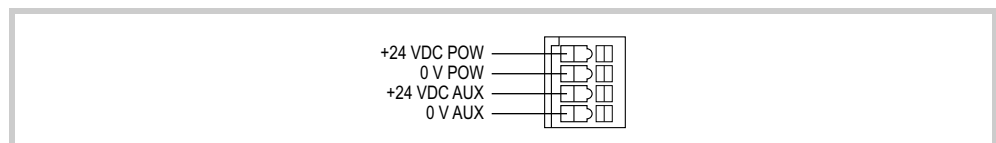

Fig.. 20 WAGO plug connector (view from wiring side)

Connection	Configuration
+24 V DC POW	Supply voltage $U_{POW}$ +24 VDC
0 V POW	Supply voltage $U_{POW}$ 0 V
+24 V DC AUX	Supply voltage $U_{AUX}$ +24 VDC
0 V AUX	Supply voltage $U_{AUX}$ 0 V

Tab. 13 Plug connection configuration

- Observe the following when preparing the wiring of the plug connector:

Terminating the wiring with the plug connector	
Terminal type:	spring-cage terminal
Connectable conductor, solid	0.2... 1.5 mm <sup>2</sup> (AWG24...16)
Strip length	6...7 mm

Tab. 14 Terminating the wiring with the plug connector

- External overcurrent and short-circuit protective device, implemented with a miniature circuit-breaker or a fuse, is required for  $U_{AUX}$ .

## 5 Installation

### 5.3 Interfaces

Standard	Overcurrent and short-circuit protective device
DIN VDE 0641, Part 11 and IEC/EN 60898	Miniature circuit-breaker 24 VDC, rated operational current 3 A, tripping characteristic Z Fuse 3 A, utilization category gL/gG
UL 508 and CSA-22.2, No. 14	Miniature circuit-breaker 24 VDC, rated operational current 2 A, tripping characteristic Z Fuse 2 A

Tab. 15 Overcurrent and short-circuit protective device

#### 5.3.8.4

#### SWD (SmartWire-DT interface)

The SWD interface is **not** galvanically isolated.

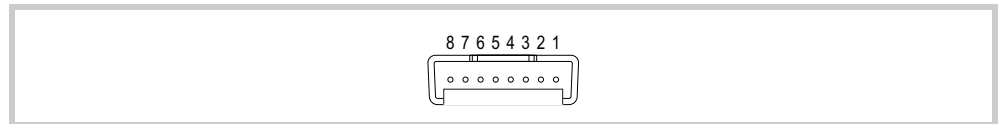



Fig.. 21 SWD interface (plug, 8-pin)

#### Cabling

- Use only the following ribbon cables for connecting the SmartWire-DT network at the SWD interface:
    - SWD4-100LF8-24 with the relevant blade terminals SWD4-8MF2 or
    - SWD4-(3/5/10)F8-24-2S (prefabricated cable)
-  **Detailed instructions on fitting the blade terminal SWD4-8MF2 are provided in the Document «SmartWire-DT The System Manual MN05006002Z», Chapter «Fitting the blade terminal SWD4-8MF2».**



### 5.3.8.5

#### Commissioning the SmartWire-DT network

##### Switching on for initial startup, a replacement or a changed SmartWire-DT configuration

Requirement:

- All SmartWire-DT modules must be connected to each other via SmartWire-DT cables.
- The SmartWire-DT network must be connected to the SmartWire-DT interface.
- The power supply for the device and for SmartWire-DT must be on and connected.
- The SmartWire-DT master's POW LED must be lit up with a solid light.
- The SmartWire-DT status LEDs of the connected SmartWire-DT modules must be flashing or showing a solid light.
- A PLC project with configured SWD-Master exists (project configuration).
- The PLC runtime system must be installed on the device.

Procedure:

- 1 Press the configuration button «Config» for at least two seconds.
  - The SWD LED of the SmartWire-DT Master interface begins to flash orange and the SmartWire-DT status LEDs on the connected SmartWire-DT slaves flash.
  - The SmartWire-DT master interface's SWD LED will start flashing with a green light
  - All SmartWire-DT modules are addressed.
  - The SmartWire-DT network's physical configuration will be stored in the device's non-volatile memory as a target configuration.
  - The SmartWire-DT master interface's SWD LED will start showing a solid green light.
- 2 Download the PLC project onto the device.
  - If the project configuration is identical to the stored target configuration, the Config LED lights up green and the data exchange of the input and output data can start.

**Configuration check**

Each time the supply voltage is switched on, the configuration checks are performed:

- 1 The slaves actually found on the network are compared with the target configuration stored in the device.
  - If the physical structure of the SmartWire-DT network matches the target configuration, the SmartWire-DT network is ready for data exchange.
- 2 The target configuration stored in the device is compared with the project configuration defined in the PLC.
  - If the target configuration matches the project configuration, the Config LED lights up.

LED	State	Meaning
Smart-Wire-DT	Off	No target configuration present.
	Continuous red light	<ul style="list-style-type: none"> <li>■ Short-circuit on the 15 V DC power supply.</li> <li>■ No SmartWire-DT module found.</li> </ul>
	Red flashing	<ul style="list-style-type: none"> <li>■ The modules found in the SmartWire-DT network do not match the target configuration.</li> <li>■ A SmartWire-DT module configured as necessary is missing.</li> </ul>
	Orange flashing	The physical configuration of the SmartWire-DT network is read in and stored in the device as the target configuration.
	Green flashing	<ul style="list-style-type: none"> <li>■ The physical configuration of the SmartWire-DT network is compared with the target configuration.</li> <li>■ The SmartWire-DT modules are addressed.</li> </ul>
	Continuous green light	The modules found in the SmartWire-DT network match the target configuration. The SmartWire-DT network is ready for data exchange.
Config	Off	<ul style="list-style-type: none"> <li>■ No project configuration present.</li> <li>■ Faulty target configuration (see SWD-LED).</li> </ul>
	Continuous red light	The project configuration and the stored target configuration are not compatible.
	Green flashing	The project configuration is compatible with the stored target configuration.
	Continuous green light	The project configuration is identical to the stored target configuration.

Tab. 16 SWD-LED and Config LED



**The description of the project configuration (SmartWire-DT configuration in XSoft-CODESYS project) are provided in the Document «User Manual XSOFT-CODESYS 2 MN04802091Z, PLC programming» or «User Manual XSOFT-CODESYS 3 MN048008ZU, PLC programming», Chapter «SmartWire-DT configuration».**

5.3.9

CAN

The CAN interface is **not** galvanically isolated.

CAUTION	
	<p><b>Non-galvanically-isolated interfaces</b></p> <p>The device may be damaged by potential differences.</p> <p>▶ The GND terminals of all bus modules must be connected.</p>

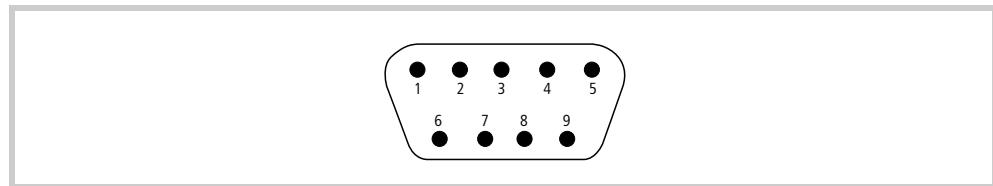



Fig.. 22 CAN interface (9-pin, D-Sub, male, UNC)

Pin	Signal	Configuration
1	-	nc
2	CAN-L	Bus line (dominant low)
3	CAN-GND	CAN Ground
4	-	nc
5	-	nc
6	GND	Optional CAN ground
7	CAN-H	Bus line (dominant high)
8	-	nc
9	-	nc

Tab. 17 Pin assignment of CAN interface in accordance with CiA

-  ■ Pin 3 (CAN-GND) and 6 (GND) are internally interconnected
- nc: Pin 1, 4, 5, 8 and 9 must not be connected.
- The power supply of the CAN bus drivers is implemented internally.
- A power supply for third party devices is not provided on the CAN connector.

Wiring

- Screened twisted-pair cables must be used.

Cable specifications	
Rated surge impedance	120 Ω
Permissible surge impedance	108... 132 Ω
Capacitance per unit length	< 60 pF/m
Core cross-section / max. cable length	≥ 0.25 mm <sup>2</sup> / 100 m
	≥ 0.34 mm <sup>2</sup> / 250 m
	≥ 0.75 mm <sup>2</sup> / 500 m

Tab. 18 Cable specifications

- The maximal baud rate depends on the cable length

Cable length	Max. baud rate
25 m	1000 kbit/s
50 m	800 kbit/s
100 m	500 kbit/s
250 m	250 kbit/s
500 m	125 kbit/s
500 m	100 Kbit/s (adjustable via software)
1000 m	50 kbit/s
2500 m	20 kbit/s
5000 m	10 kbit/s

Tab. 19 Relationship of cable length / baud rate

- 
  - The use of repeaters is recommended for cable lengths over 1000 m. Repeater can also be used to implement galvanic isolation. Refer to the documentation of the repeater manufacturer for more specific details.
  - Observe the recommendations of CiA (CAN in Automation).
  - When preparing the cables, ensure that there is a low-resistance connection between the cable screen and the connector casing (→ Chapter 5.3.2, 28).

CAN-Bus-topology

- A bus segment can interconnect up to 32 slaves.
  - Several bus segments can be connected using repeaters (bi-directional amplifiers). Refer to the documentation of the repeater manufacturer for more specific details.
  - A bus segment must be provided with cable termination ( $120\ \Omega$ ) at both ends. These terminals must be connected in the connector directly between pin 2 and 7.
- ☞
- **The bus segment must be terminated at both ends.**
  - **No more than two terminations must be provided for each bus segment.**
  - **Operation without correct cable termination can cause transfer errors.**

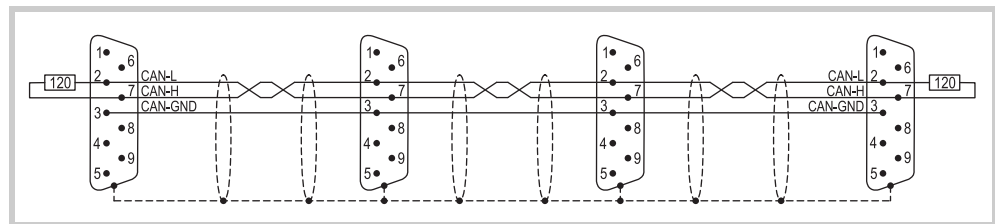

Fig.. 23 Bus segment with four nodes

## 5 Installation

### 5.3 Interfaces

#### 5.3.10

#### Profibus

The Profibus interface is **not** galvanically isolated.

CAUTION	
	<p><b>Non-galvanically-isolated interfaces</b></p> <p>The device may be damaged by potential differences.</p> <p>▶ The GND terminals of all bus modules must be connected.</p>

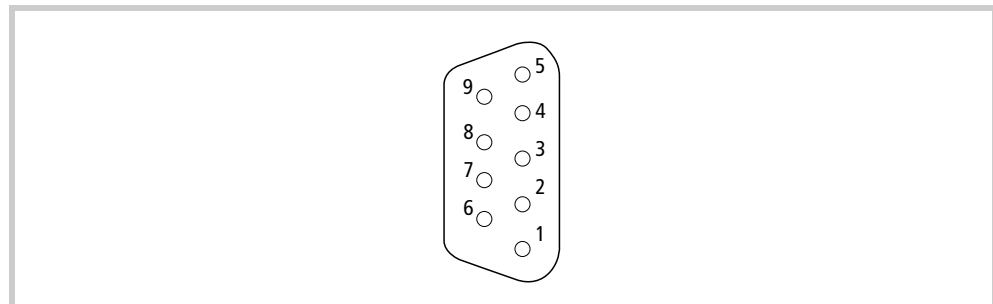



Fig.. 24 Profibus interface (9-pin, D-Sub, female, UNC)

Pin	Signal	Configuration
1	-	nc
2	-	nc
3	B	EIA RS 485 line B
4	RTSAS	Output for controlling a repeater
5	M5EXT	Output 0 V for external termination
6	P5EXT	Output 5 V for external termination
7	-	nc
8	A	EIA RS 485 line A
9	-	nc

Tab. 20 Pin assignment of the Profibus interface

 **Pin 6 (5 V) must not be used as a power supply for external devices.**

Wiring

- Screened twisted pair cables, cable type A (in accordance with Profibus standards IEC/EN 61158 and IEC/EN 61784) must be used.

**Cable specifications**

Rated surge impedance	150 $\Omega$
Permissible surge impedance	135 ... 165 $\Omega$
Capacitance per unit length	< 30 pF/m
Loop resistance	< 110 $\Omega$ /km
Core cross section	$\geq 0.34 \text{ mm}^2$ (22 AWG)

Tab. 21 Cable specifications

- The maximal baud rate depends on the cable length

Cable length	Max. baud rate
200 m	1500 kbit/s
400 m	500 kbit/s
1000 m	187.5 kbit/s
1200 m	$\leq 93.75$ kbit/s

Tab. 22 Relationship of cable length / baud rate (for cables compliant with cable type A of the Profibus standard IEC/EN 61158 and IEC/EN 61784)

- ☞ **When preparing the cables, ensure that there is a low-resistance connection between the cable screen and the connector casing (→ Chapter 5.3.2, 28).**

## 5 Installation

### 5.3 Interfaces

#### Profibus topology

- A bus segment can interconnect up to 32 slaves.
- Several bus segments can be connected using repeaters (bi-directional amplifiers). Refer to the documentation of the repeater manufacturer for more specific details.



**The use of repeaters enables the maximum cable length to be increased. Refer to the documentation of the repeater manufacturer for more specific details.**

- Only use bus terminal connectors that are specified for use in the Profibus network. They hold both bus cables on a bus station and ensure a low impedance connection of the cable screen to the shield reference potential of the bus station. These bus terminal connectors contain the Profibus cable termination that can be switched on as required.
- A bus segment must be provided with cable termination at both ends. This termination is passive, but is fed from the node. It ensures a defined quiescent signal on the bus if no bus station is sending. These bus terminations should be implemented externally in the connector casing according to the Profibus standard (they can also be implemented with the bus terminating connector described above).

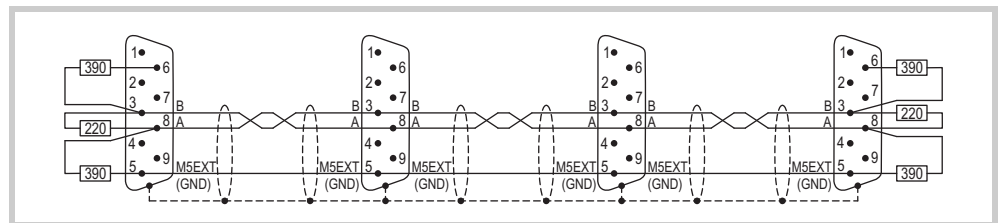

Fig.. 25 Bus segment with four nodes



- **The bus segment must be terminated at both ends.**
- **No more than two terminations must be provided for each bus segment.**
- **At least one of the two terminations must be fed by the bus station.**
- **Operation without correct termination of the Profibus network can cause transfer errors.**



5.3.11

RS485

The RS485 interface is **not** galvanically isolated.

CAUTION	
	<p><b>Non-galvanically-isolated interfaces</b></p> <p>The device may be damaged by potential differences.</p> <p>▶ The GND terminals of all bus modules must be connected.</p>

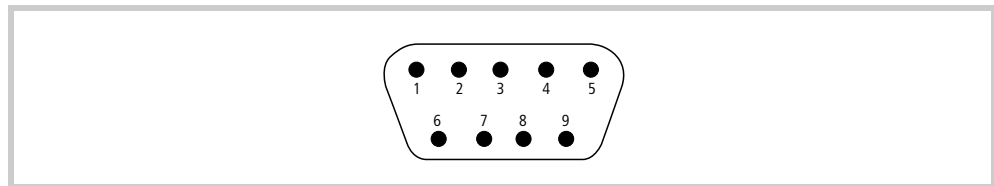



Fig.. 26 RS485 interface (9-pin, D-Sub, male, UNC)

Pin	Signal	Configuration
1	-	nc
2	-	nc
3	B	Line B
4	-	nc
5	GND	Ground
6	-	nc
7	A	Line A
8	-	nc
9	-	nc

Tab. 23 Pin assignment of the RS485 interface

 **nc: Pin 1, 2, 4, 6, 8 and 9 must not be connected.**

## 5 Installation

### 5.3 Interfaces

#### Wiring

Screened twisted-pair cables must be used.

Cable specifications	
Rated surge impedance	120 $\Omega$
Permissible surge impedance	108... 132 $\Omega$
Max. cable length	1200 m
Possible baud rates	9600 Bit/s
	19200 Bit/s
	38400 Bit/s
	57600 Bit/s
	115200 bit/s

Tab. 24 Cable specifications

 **When preparing the cables, ensure that there is a low-resistance connection between the cable screen and the connector casing (→ Chapter 5.3.2, 28).**

#### RS485-topology

- A bus segment can interconnect up to 32 slaves.
- Several bus segments can be connected using repeaters (bi-directional amplifiers). Refer to the documentation of the repeater manufacturer for more specific details.

 **The use of repeaters enables the maximum cable length to be increased. Refer to the documentation of the repeater manufacturer for more specific details.**

- A bus segment must be provided with cable termination (120  $\Omega$ ) at both ends. These terminals must be connected in the connector directly between pin 3 and 7.

-  ■ **The bus segment must be terminated at both ends.**
- **No more than two terminations must be provided for each bus segment.**
  - **Operation without correct cable termination can cause transfer errors.**

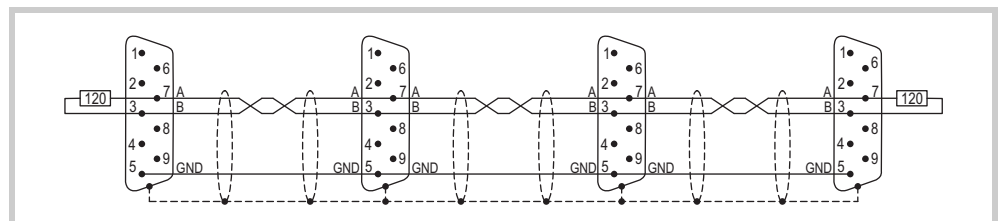

Fig.. 27 Bus segment with four nodes

## 5.4

### Mounting

#### CAUTION



##### Interference

The values specified in the technical data and the device's electromagnetic compatibility (EMC) cannot be guaranteed if unsuitable cables, improperly assembled and terminated cables, and/or unprofessional wiring are used.

- ▶ Only use cables prefabricated and terminated by professionals.
- ▶ The cables being used must be assembled and terminated as required by the port/interface description in this document.
- ▶ When wiring the device, follow all instructions regarding how to wire the corresponding port/interface.
- ▶ All general Directives and standards must be complied with.

#### CAUTION



##### Condensation in/on the device

If the device is or was exposed to climatic changes (temperature fluctuation, air humidity) moisture can form on or in the device (device condensation). In this case, there is a risk of short-circuit.

- ▶ The device must **not** be switched on when device condensation is present.
- ▶ If the device has condensation in or on it, or if the device has been exposed to temperature fluctuations, let the device settle into the existing ambient air temperature before switching it on (do not expose the device to direct thermal radiation from heating appliances).

- 1 Check the device for transit damage.



**The device must only be installed and commissioned in perfect technical condition and in compliance with this document.**

- 2 Mount the device in the control cabinet, control panel or the control desk. See chapter 5.4.1 Mounting the device, 50
- 3 Connect the device as required for your application.
  - Follow the instructions on wiring the relevant interface. See chapter 5.3 Interfaces, 25



**The device does not have an ON/OFF switch. The device is not provided with an On/Off switch. If the power supply is not provided with a switch, the device will start up (boot) as soon as it is connected to the power supply.**

## 5 Installation

### 5.4 Mounting

#### 5.4.1

#### Mounting the device

- 1 Select the mounting position of the device as described in Chapter 5.2.3 Requirements for the mounting position, 24.
- 2 Make a mounting cutout for the device at the selected location:
  - Mounting cutout:
    - 3.5" devices:  $123 \times 87$  mm ( $\pm 1$  mm)
    - 5.7" devices:  $157 \times 117$  mm ( $\pm 1$  mm)
    - 7.0" devices:  $197 \times 122$  mm ( $\pm 1$  mm)
  - Material thickness at the mounting cutout 2...5 mm

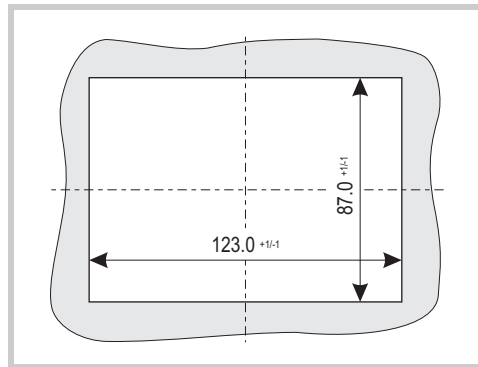

Fig.. 28 Mounting cutout for 3.5" devices

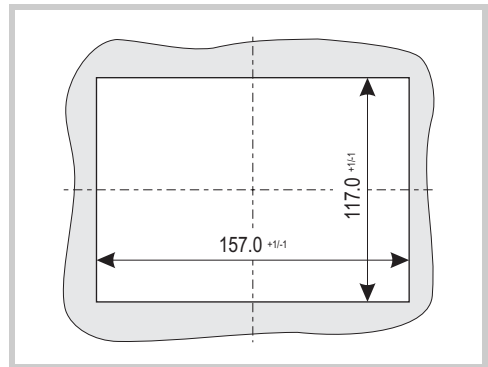

Fig.. 29 Mounting cutout for 5.7" devices

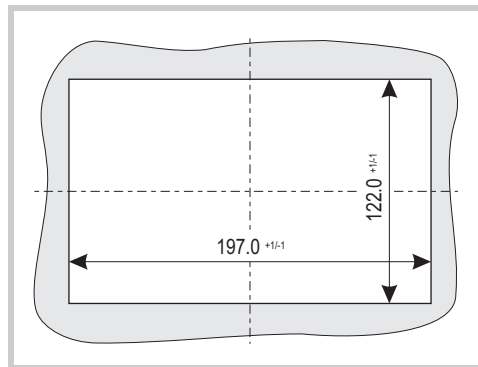



Fig.. 30 Mounting cutout for 7.0" devices

- 3 If a cord gasket has not been glued inside groove (A) at the back of the device's front plate already, insert the enclosed gasket cord into groove (A) and cut it to length in such a way that there is no gap at the joint.

**CAUTION**

 **Poor sealing**

Poor sealing resulting from the twisting of the sealing strip or due to a gap between the ends of the sealing strip.

- ▶ The join of the sealing strip must be positioned on the bottom of the device.
- ▶ Do **not** twist the sealing strip when it is inserted.
- ▶ Cut the sealing strip to a suitable length so that the join is tight.

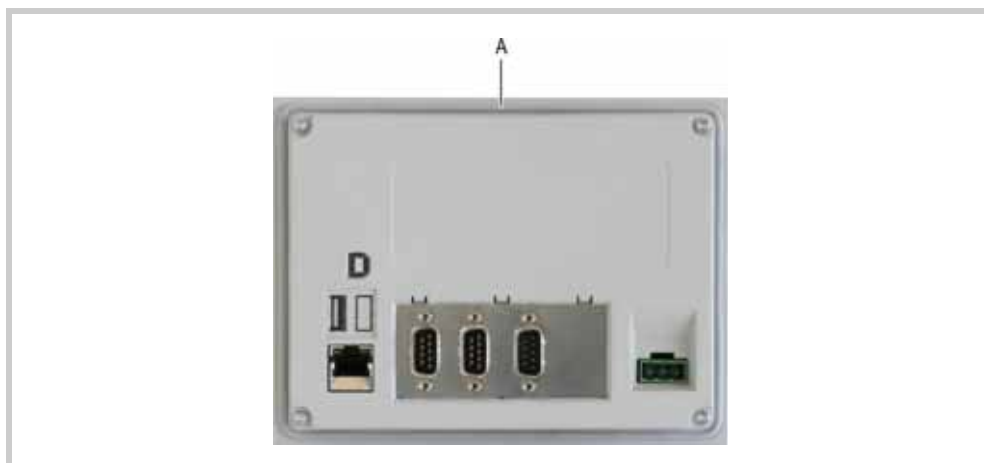



Fig.. 31 Groove for sealing strip (A)

- 4 Fit the supplied threaded pins in the retaining brackets beforehand.
  - The tips of the threaded pins must point towards the wider ends of the retaining brackets.



Fig.. 32 Set screw pre-assembled in holding bracket

- 5 Insert the device into the mounting cutout from the front.
- 6 Clip on the retaining brackets in the recesses provided for them on the device as shown below and fix the device by tightening the threaded pins until the front of the MICRO PANEL is flush with the surface of the control cabinet at the fixing points.

CAUTION	
	<p><b>Mechanical damage to the device</b></p> <p>Tightening the set screws too tight may damage the device.</p> <p>▶ Tighten threaded pins with a max. tightening torque of 0.1 Nm.</p>

 **The positions of the retaining brackets depend on:**

- the size of the device and
- the mounting requirements.

- 3.5" devices:
  - One retaining bracket each at all four fixing positions



Fig.. 33 3.5" devices with four retaining brackets (meet IP65 / NEMA 4X requirements)

- 5.7" devices (standard mounting):
  - Top and bottom of the device:  
Fit one retaining bracket each at the left and right fixing position



Fig.. 34 5.7" devices with four retaining brackets (do not meet IP65 / NEMA 4X requirements)

- 5.7" devices which must be mounted in accordance with IP65 / NEMA 4X or used in potentially explosive atmospheres:
  - One retaining bracket each at all six fixing positions



Fig.. 35 5.7" devices with six retaining brackets (meet IP65 / NEMA 4X requirements)

- 7.0" devices (standard mounting):
  - Top and bottom of the device:  
Fit one retaining bracket each at the left and right fixing position



Fig.. 36 7.0" devices with four retaining brackets (do not meet IP65 / NEMA 4X requirements)

- 7.0" devices which must be mounted in accordance with IP65 / NEMA 4X or used in potentially explosive atmospheres:
  - One retaining bracket each at all eight fixing positions



Fig.. 37 7.0" devices with eight retaining brackets (meet IP65 / NEMA 4X requirements)

## 5 Installation

### 5.4 Mounting

#### 5.4.2

#### Screening the communication cables used

In order to ensure that signals are transmitted without noise so as to comply with EMC B requirements, the communication cables used must be screened.

- Use screened cables or screen the cables yourself with a ferrite ring such as:
  - Würth STAR-RING snap-together ferrite, split ferrite core, 30 x 20 x 20 mm, for cables with a diameter of 8 mm
  - Würth STAR-GAP snap-together ferrite, split ferrite core, 31.5 x 35 x 28.3 mm, for cables with a diameter of 13 mm
- ▶ Make sure to properly place the ferrite ring on the communication cable at a location close to the connection side (max. distance of 20 cm from the external device plug) on the touch display.

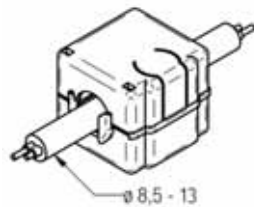



Fig.. 38 Screening with snap-together ferrite ring

- ☞ 2.7 Marine approvals, 12
- 5.2.2 Conditions for marine approval (DNV GL), 23
- 5.3.3 Section Radio interference suppression filter for the 24 V DC supply, 31



## 6 Operation

### 6.1 Safety regulations

 Read Chapter 3 Safety regulations, 13, before working with the device. This contains important information for your personal safety.

#### CAUTION



##### Sensitive resistive touch surface

Damage to the resistive touch due to the use of pointed or sharp objects.

- ▶ Only activate the resistive touch with your finger or a stylus.
- ▶ When wearing gloves, ensure that these are clean. They must not be covered with abrasive dust or sharp particles.

#### CAUTION



##### Condensation in/on the device

If the device is or was exposed to climatic changes (temperature fluctuation, air humidity) moisture can form on or in the device (device condensation). In this case, there is a risk of short-circuit.

- ▶ The device must **not** be switched on when device condensation is present.
- ▶ If the device has condensation in or on it, or if the device has been exposed to temperature fluctuations, let the device settle into the existing ambient air temperature before switching it on (do not expose the device to direct thermal radiation from heating appliances).

## 6 Operation

### 6.2 Starting the device

#### 6.2

#### Starting the device

- 1 Energize the device.
  - The device will boot.
- 2 If the device does not boot up and/or if an error message appears while starting (booting) the device, see Chapter 7.4 Troubleshooting,  61
- 3 Complete the following steps after initial commissioning (→ Document «System Description Windows CE MN05010007Z (operation of the Windows CE operating system on touch displays)»)
  - 3.1 Adjust the system settings of the device.
  - 3.2 Install the required application programs.



**The lifespan of the backlight can be increased by reducing the brightness (→ Document «System Description Windows CE MN05010007Z (operation of the Windows CE operating system on touch displays)»).**

#### 6.3

#### Switch off the device

- 1 De-energize the device.

## 6.4

### Inserting and removing the SD card

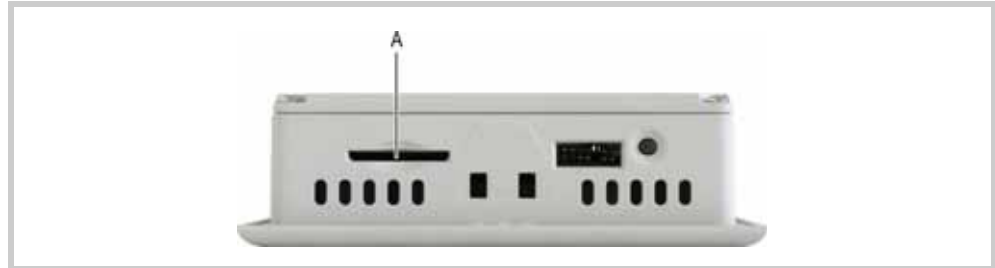

Fig.. 39 SD Slot (A)

#### CAUTION



##### Data loss

During a write operation, the SD card may lose data or may be destroyed if it is removed or if there is a power failure.

- ▶ Insert the SD card only when the device is de-energized.
- ▶ Avoid writing to SD cards as much as possible. Reasons:
  - SD cards have a limited number of write cycles.
  - If there is a voltage drop while a write operation is in progress, data loss is highly likely to occur.
- ▶ Remove the SD card only when the device is de-energized.
- ▶ Before switching off, ensure that no software write operations to the SD card are in progress.

 **Do not apply any force (SD cards are protected against reverse insertion).**

#### Inserting the SD card

- 1 Push the SD card into the SD slot (A) until it snaps into position.

#### Removing the SD card

- 1 Push the SD card in the SD slot (A) all the way in.
  - This releases the lock mechanism and the SD card comes out of the SD slot a little.
- 2 Remove the SD card from the SD slot.

## 6 Operation

### 6.4 Inserting and removing the SD card

## 7 Maintenance and repairs

### 7.1 Safety regulations

 **Read Chapter 3 Safety regulations, 13, before working with the device. This contains important information for your personal safety.**

### 7.2 Maintenance

Devices with resistive touch are maintenance-free. However, the following work may be necessary:

- Cleaning the resistive touchscreen when soiled.
- Recalibrating the resistive touchscreen if it stops responding correctly to touch.

#### 7.2.1 Cleaning the resistive touchscreen

CAUTION	
	<p><b>Cleaning the device</b></p> <p>Damage to the device due to the use of pointed or sharp objects or by liquids.</p> <ul style="list-style-type: none"> <li>▶ Do not use any pointy or sharp objects (e.g., knives) to clean the device.</li> <li>▶ Do not use aggressive or abrasive cleaning products or solvents.</li> <li>▶ Prevent liquids from getting into the device (short-circuit hazard).</li> </ul>

- 1 Carefully clean the resistive touchscreen with a clean, soft, damp cloth.
  - If there are any spots that are proving difficult to get off, spray a little dishwashing liquid on the damp cloth first.

#### 7.2.2 Recalibrating the resistive touchscreen

The resistive touchscreen will already be calibrated when you receive it. However, it will have to be recalibrated if it stops responding correctly to touch. Touch calibration, see Document «System Description Windows CE MN05010007Z (operation of the Windows CE operating system on touch displays)».

#### 7.2.3 Battery

The integrated battery cannot be exchanged. Lifespan, see Chapter 9.4 System, 69

## 7 Maintenance and repairs

### 7.3 Maintenance

#### 7.3 Maintenance

##### 7.3.1 Repairs

The device should only be opened by the manufacturer or by an authorized repair center.

Contact your local supplier or Eaton technical support for repairs.

Only the original packaging should be used for transporting the device.

## 7.4

## Troubleshooting

Fault and possible cause	Corrective action
Device does not start (boot).	
Power supply interface does not have any power.	Check the input wiring.
While the device is starting (booting), the following message appears:	
«<50> Touch is dirty or defect» (only appears if GALILEO is installed)	
The resistive touchscreen is not calibrated correctly.	<ul style="list-style-type: none"> <li>■ Start the device (boot it up).</li> <li>■ Calibrate touch. (→ Document «System Description Windows CE MN05010007Z (operation of the Windows CE operating system on touch displays)»).</li> </ul>
The set screws used to mount the device are too tight.	Loosen the threaded pins (observe max. torque, → Chapter 5.4.1, 50)
The device is faulty.	Send the device in for repairs.
The display stays or turns dark.	
The backlight is deactivated.	Check the function in the visualization software.
The backlight is faulty.	Send the device in for repairs.
Touch does not react or does not react correctly to touch operation.	
The resistive touchscreen is not calibrated correctly.	<ul style="list-style-type: none"> <li>■ Start the device (boot it up).</li> <li>■ Calibrate touch. (→ Document «System Description Windows CE MN05010007Z (operation of the Windows CE operating system on touch displays)»).</li> </ul>
The touch is disabled.	<ul style="list-style-type: none"> <li>■ Start the device (boot it up).</li> <li>■ Activate touch (→ Document «System Description Windows CE MN05010007Z (operation of the Windows CE operating system on touch displays)»).</li> </ul>
The icon  appears in the taskbar.	
Incorrect operation of the operating elements on the display.	Remove all objects (including fingers) from the display area.
The set screws used to mount the device are too tight.	Loosen the threaded pins (observe max. torque, → Chapter 5.4.1, 50)
The device is faulty.	Send the device in for repairs.

Tab. 25 Troubleshooting

## 7 Maintenance and repairs

### 7.4 Troubleshooting



## 8 Storage, transport and disposal

### 8.1 Safety regulations



**Read Chapter 3 Safety regulations, 13 before installing and commissioning the device. This contains important information for your personal safety.**

### 8.2 Storage

The ambient conditions for storage need to be met. See chapter 9.9 Environmental conditions, 76

### 8.3 transport

When transporting or shipping the device, make sure that the device is not damaged (use appropriate packaging).

All ambient conditions need to be met during transportation and shipping as well. See chapter 9.9 Environmental conditions, 76

- 1 Check the device for transit damage after arrival.

## 8 Storage, transport and disposal

### 8.4 Disposal

#### 8.4

#### Disposal

**⚠ DANGER**



**Explosive and toxic materials**

The lithium battery soldered inside the device may explode if handled incorrectly.

▶ Dispose of the device properly.

Devices no longer being used must be professionally disposed of as per local standards or returned to the manufacturer or relevant sales department.

#### Materials used in the device

Assembly part	Material characteristic
Housing	PC-GF
Resistive touch protective screen	Glass with polyester layer
Battery	Lithium CR 2032, 3.0 V, 220 mAh, Panasonic
■ Battery weight	3.4 g
■ SVHC Substance	1.2-dimethoxyethane: ethylene glycol dimethyl ether (EGDME)
■ Substance weight	2-4 %
Electrical components	Various

Tab. 26 Materials used in the device



**The materials used for our housings are halogen-free.**

#### Materials used in the packaging

Packaging	Material characteristic
External packaging	Cardboard
Internal packaging:	
3.5" devices	■ Cardboard with PE sheet ■ Plastic bag: polyethylene (PE)
5.7" and 7.0" devices	■ Cardboard ■ Plastic bag: polyethylene (PE)

Tab. 27 Materials used in the packaging

## 9 Technical data

### 9.1 Dimensions and weights

#### 9.1.1 3.5" devices

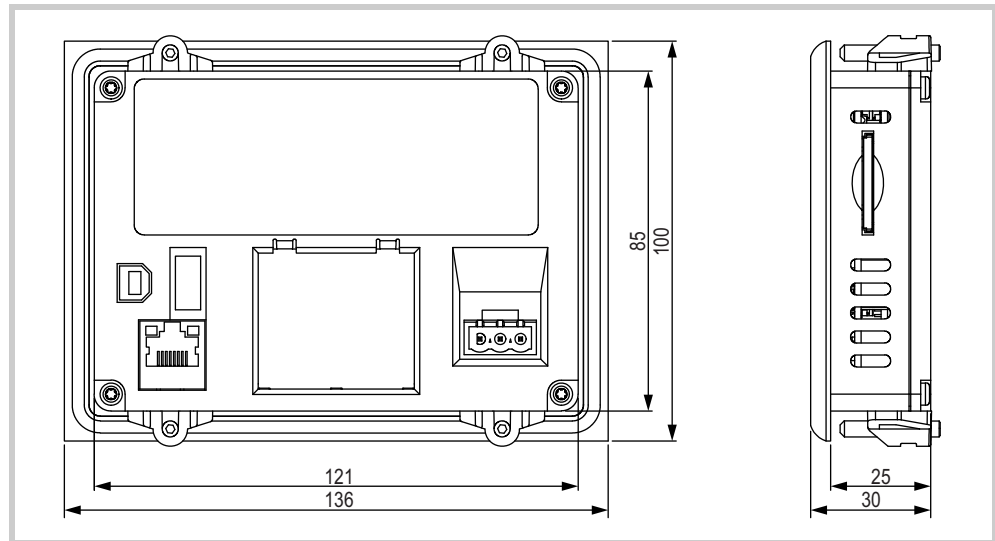

Fig.. 40 Mechanical dimensions of the 3.5" devices in mm

Property	XV-102 3.5"
Height	100 mm
Width	136 mm
Depth	30 mm
Thickness of front plate	5 mm
Built-in depth	25 mm
Installation cut-out	123 mm × 87 mm (±1 mm)
Weight	Approx. 0.3 kg

Tab. 28 Dimensions and weights of the 3.5" devices

## 9 Technical data

### 9.1 Dimensions and weights

#### 9.1.2

#### 5.7" devices

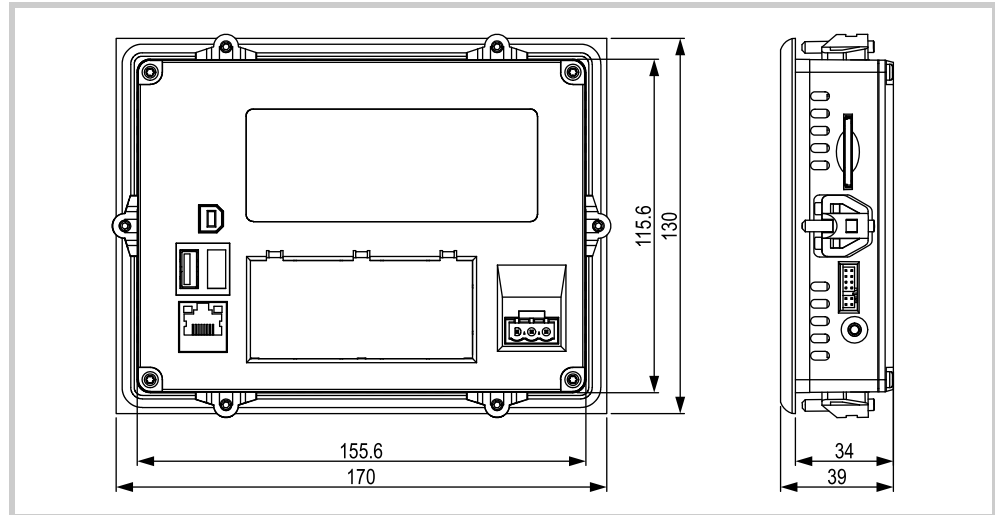

Fig.. 41 Mechanical dimensions of the 5.7" devices in mm

Property	XV-102 5.7"
Height	130 mm
Width	170 mm
Depth	39 mm
Thickness of front plate	5 mm
Built-in depth	34 mm
Installation cut-out	157 mm × 117 mm (±1 mm)
Weight	Approx. 0.6 kg

Tab. 29 Dimensions and weights of the 5.7" devices

9.1.3

7.0" devices

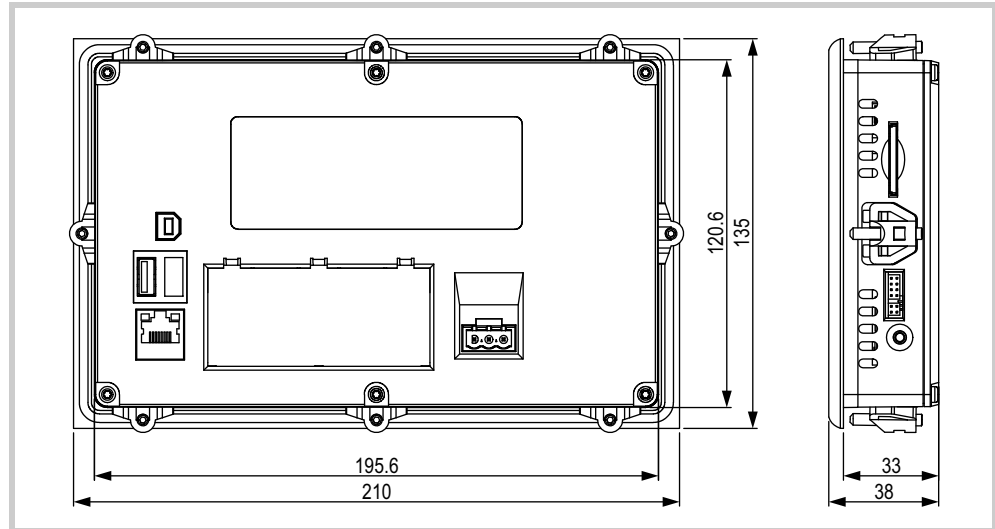

Fig.. 42 Mechanical dimensions of the 7.0" devices in mm

Property	XV-102 7.0"
Height	135 mm
Width	210 mm
Depth	38 mm
Thickness of front plate	5 mm
Built-in depth	33 mm
Installation cut-out	197 mm × 122 mm (±1 mm)
Weight	Approx. 0.6 kg

Tab. 30 Dimensions and weights of the 7.0" devices

9.2

Display

Property	XV-102
Part no.	TFT-LCD
Resolution (W × H)	
3.5" devices	QVGA (320 × 240 pixels)
5.7" devices	VGA (640 × 480 pixels)
7.0" devices	WVGA (800 × 480 pixels)
Visible screen area	
3.5" devices	70 mm × 53 mm (3.5" screen diagonal)
5.7" devices	115 mm × 86 mm (5.7" screen diagonal)
7.0" devices	152 mm × 91 mm (7.0" screen diagonal)
Color resolution	
3.5" devices	
XV-102-...-35MQR...	32 gray levels
XV-102-...-35TQR...	64k colors
5.7" and 7.0" devices	64k colors
Contrast ratio (Normally)	Normally 300:1
Brightness	Normally 250 cd/m <sup>2</sup>
Backlight	
Technology	LED
Dimmable with software	
3.5" devices	100 % ... 1 % brightness
5.7" devices	100 % ... 30 % brightness
7.0" devices	100 % ... 20 % brightness
lifespan	Normally 40 000 h
Resistive touch protective screen	Touch sensor (glass with foil)

Tab. 31 Display

9.3

Touch sensor

Property	XV-102
Part no.	Resistive-Touch
Technology	4 conductor

Tab. 32 Touch sensor

9.4

System

Property	XV-102
Processor	RISC, 32 Bit, 400 MHz
Internal memory	
DRAM	64 MByte
NAND flash	64 MByte
NVRAM	
XV-102-A...	–
All device versions except XV-102-A...	125 kByte
NOR flash	
3.5" devices	–
5.7" and 7.0" devices	2 MByte
External memory	
SD Memory Card Slot	1 × SDA specification 1.00 Suitable for SD cards ( <b>not</b> for SDHC cards or cards of newer standard) Only use original accessories.
Real-time clock (battery back-up)	
Battery type	CR2032 (190 mA/h), maintenance-free (soldered)
Backup time at zero voltage	Normally 10 years

Tab. 33 System

## 9.5

### Interfaces

Property	XV-102
Ethernet	100Base-TX / 10Base-T
USB Device	USB 2.0, not galvanically isolated
Interfaces, depending on the device version:	
USB Host	USB 2.0 (1.5 / 12 / 480 MBit/s), not galvanically isolated
SmartWire-DT Master	SmartWire-DT, not galvanically isolated → Chapter 9.5.2, 72
RS232 (System Port)	RS232, not galvanically isolated
CAN	CAN, not galvanically isolated
Profibus	Profibus, not electrically isolated, max. 1.5 Mbit/s
RS485	RS485, not galvanically isolated
Power supply	→ Chapter 9.5.1, 71
DIAG	Only for service tasks
UPD/RUN jumper	Only for service tasks

Tab. 34 Interfaces



9.5.1

Power supply

Property	XV-102
Rated operating voltage	24 V DC SELV (safety extra low voltage)
Permissible voltage	<ul style="list-style-type: none"> <li>■ Effective: 19.2...30.0 VDC (rated operating voltage -20 % / +25 %)</li> <li>■ Absolute with ripple: 18.0...31.2 VDC</li> <li>■ Battery operation: 18.0...31.2 VDC (Rated operating voltage -25 % / +30 %)</li> <li>■ 35 V DC for a period &lt; 100 ms</li> </ul>
Voltage dips	<ul style="list-style-type: none"> <li>■ 10 ms from rated operating voltage (24 VDC)</li> <li>■ 5 ms from undervoltage (20.4 VDC)</li> </ul>
Power consumption	
3.5" devices	Max. 5 W
5.7" and 7.0" devices	
Basic device	Max. 7 W
USB device on USB host	Max. 2.5 W
Total	Max. 9.5 W
Current consumption	
Continuous current	Max. 0.4 A (24 VDC)
Continuous current	
3.5" devices	Max. 0.2 A (24 VDC)
5.7" and 7.0" devices	Max. 0.4 A (24 VDC)
Starting current inrush	1.5 A <sup>2</sup> s
Protection against polarity reversal	Yes
fuse	Yes (replacement only by the manufacturer or by an authorized repair center)
Potential isolation	No

Tab. 35 Power supply

9.5.2

SmartWire-DT Master

9.5.2.1

POW/AUX (power supply interface for SmartWire-DT)

Property	XV-102
Supply voltage $U_{Aux}$ (control voltage for contactor coils)	
Operational voltage	
Rated operating voltage	24 VDC
Permissible voltage	Effective: 20.4...28.8 V DC (rated operating voltage -15 % / +20 %)
Input voltage residual ripple	Max. 5 %
Protection against polarity reversal	Yes
Current	
In accordance with DIN VDE 0641, Part 11 Max. 3 A <sup>1)</sup> and IEC/EN 60898	
In accordance with UL 508 and CSA-22.2, No. 14	
Short-circuit rating	No, external protection required (e.g. FAZ Z3, → Chapter 5.3.8.3, 37)
Heat dissipation	Normally 1 W
Potential isolation	No
Rated operating voltage of 24 V DC slaves	Normally $U_{Aux} - 0.2$ V
Supply voltage $U_{Pow}$ (for SmartWire-DT slaves)	
Specifications for connection to supply voltage	
Rated operating voltage	24 VDC
Permissible voltage	Effective: 20.4...28.8 V DC (rated operating voltage -15 % / +20 %)
Input voltage residual ripple	Max. 5 %
Protection against polarity reversal	Yes
Current	Max. 0.7 A
Overload proof	Yes
Inrush current and length	12.5 A/6 ms
Heat dissipation at 24 VDC	1.0 W
Potential isolation between $U_{Pow}$ and 15 V SmartWire-DT supply voltage	No
Bridging voltage dips	10 ms

Property	XV-102
Repetition rate	1 s
Status indication	Yes (LEDs)

Tab. 36 POW/AUX (power supply interface for SmartWire-DT)

- 1) 1) If contactors and/or motor starters with a total current draw > 3 A (DIN VDE 0641, Part 11 and IEC/EN 60898) or > 2 A (UL 508 and CSA-22.2, No. 14) are connected, an EU5C-SWD-PF1 or EU5C-SWD-PF2 power feeder module needs to be used.

### 9.5.2.2

#### SWD (SmartWire-DT interface)

Property	XV-102
SmartWire-DT supply voltage $U_{VP}$	
Rated operating voltage (internally converted supply voltage $U_{POW}$ )	14.5 V DC $\pm 3\%$ (14.0... 15.0 VDC)
Current	Max. 0.7 A <sup>1)</sup>
Short-circuit rating	Yes
Number of SmartWire-DT modules on the SmartWire-DT network	Max. 99
SmartWire-DT module address setting	Automatic
Baud Rate	<ul style="list-style-type: none"> <li>■ 125 kbit/s</li> <li>■ 250 kBit/s</li> </ul> (= default settings)

Tab. 37 SWD (SmartWire-DT interface)

- 1) If SmartWire-DT modules with a total current draw > 0.7 A are connected, an EU5C-SWD-PF2 power feeder module needs to be used.

## 9 Technical data

### 9.6 IP degrees of protection on the device

#### 9.6

#### IP degrees of protection on the device

Property	XV-102
Front	IP65, enclosure type 4X (indoor use only) Required number of retaining brackets and threaded pins for mounting: <ul style="list-style-type: none"><li>■ 3.5" devices: 4 pieces each</li><li>■ 5.7" devices: 6 pieces each</li><li>■ 7.0" devices: 8 pieces each</li></ul>
Rear side	IP20, enclosure type 1

Tab. 38 IP degrees of protection on the device

#### 9.7

#### Approvals and declarations

Property	XV-102
EMC	2014/30/EU
explosion safety	II 3D Ex tc IIIC T70°C IP6x (ATEX 2014/34/EU): <ul style="list-style-type: none"><li>■ Zone 22, Category 3D<sup>1)</sup></li></ul> Required number of retaining brackets and threaded pins for mounting: <ul style="list-style-type: none"><li>■ 3.5" devices: 4 pieces each</li><li>■ 5.7" devices: 6 pieces each</li><li>■ 7.0" devices: 8 pieces each</li></ul>
UL	<ul style="list-style-type: none"><li>■ Devices delivered with gasket adhesively bonded in place: UL 508, File no. E205091</li><li>■ 3.5" devices delivered with the gasket not in place already. UL 60950, File no. E208621</li></ul> Required number of retaining brackets and threaded pins for mounting: <ul style="list-style-type: none"><li>■ 3.5" devices: 4 pieces each</li><li>■ 5.7" devices: 6 pieces each</li><li>■ 7.0" devices: 8 pieces each</li></ul>
Marine approvals (shipping classification)	<ul style="list-style-type: none"><li>■ Type approval – provided that a radio interference suppression filter for the device is installed in the wiring and that the communication cables are screened. DNVGL-CG-0039, since 11/2015 Certificate No.: TAA00000NC</li></ul>

Tab. 39 Approvals and declarations

- 1) Zone 22, category 3D:  
- IP5x for group IIIB devices (nonconductive dust)  
- IP6x for group IIIC devices (conductive dust)

9.8

Applied standards and directives

Property	XV-102
EMC (relevant for CE)	
IEC/EN 61000-6-2	Interference immunity for industrial environments
IEC/EN 61000-6-4	Emitted interference for industrial environments Devices meeting this standard may not be used in residential areas
IEC/EN 61000-6-3 ■ 5.7" devices only without cable at the USB host and USB device interfaces ■ Does not apply to devices with a Smart-Wire-DT master interface	Interference immunity for residential areas, commercial and light industrial areas as well as small businesses Ethernet cable with double loop through ferrite. See Fig. 40 as per table
EMC (for marine approvals)	
2004/30/EU	Electromagnetic Compatibility (EMC) Directive
Explosion protection (relevant for CE)	
ATEX 94/9/EG: Zone 22, Category 3D (II 3D Ex tc IIIC T70°C IP6x):	
IEC/EN 60079-0	Explosive atmospheres: Equipment - General requirements
IEC/EN 60079-31	Explosive atmospheres: Equipment dust ignition protection by enclosure "t"
safety	
IEC/EN 60950 UL 60950 (only 3.5" devices)	Safety of Information Technology Equipment
UL 508	Industrial Control Equipment (technical conditions for acceptance by UL → Chapter 5.2.1, 23)
Product standards	
EN 50178	Electronic equipment for use in power installations
IEC/EN 61131-2	Programmable logic controllers: Equipment requirements and tests

Tab. 40 Applied standards and directives



Fig.. 43 Ethernet cable, double loop through ferrite

## 9 Technical data

### 9.9 Environmental conditions

#### 9.9

#### Environmental conditions

Property	XV-102
temperature	
operation	0 ... 50°C
Storage / Transport	-20 ... 60°C
Relative humidity	10 ... 95%, non-condensing
Vibration as per IEC/EN 60068-2-6	Displacement: ■ 5 ... 9 Hz: 3.5 mm ■ 9 ... 60 Hz: 0.15 mm Acceleration: ■ 60 ... 150 Hz: 2 g
Shock as per IEC/EN 60068-2-27	15 g / 11 ms
Fall test	in accordance to IEC/EN 60068-2-31

Tab. 41 Ambient conditions

# Index

## A

Ambient conditions .....	76
Applied standards and directives .....	75

## B

Battery .....	59
---------------	----

## C

CAN .....	41
CAN-Bus-topology .....	43
Control button .....	21

## D

Display .....	7
D-Sub .....	28

## E

EMC .....	28
Ethernet .....	33
Explosion protection .....	75

## L

LED	
ACT .....	33
LINK .....	33

## M

Marine approval .....	12, 74
Mounting position .....	50

## P

Package contents .....	9
Potential equalization currents .....	25

## R

Resistive touch .....	21
RS232 (System Port) .....	32
RS485 .....	47
RS485-topology .....	48

## S

SD card .....	57
SD slot .....	21

## T

Touch sensor .....	21, 68
Troubleshooting .....	61

## U

UPD .....	27, 70
USB device .....	34
USB Host .....	34

Eaton's electrical business is a global leader with expertise in power distribution and circuit protection; backup power protection; control and automation; lighting and security; structural solutions and wiring devices; solutions for harsh and hazardous environments; and engineering services. Eaton develops innovations that not only provide energy for the important things across industries worldwide, but also help customers tackle the most critical electrical power management challenges out there.

The Eaton Corporation is a diversified power management company with 2017 sales of 20.4 billion dollars. We provide energy-efficient solutions that help our customers effectively manage electrical, hydraulic, and mechanical power more efficiently, safely, and sustainably. Eaton is dedicated to improving people's quality of life and the environment through the use of power management technologies and services. Eaton has approximately 96,000 employees and sells products to customers in more than 175 countries.

For more information, please visit [Eaton.com](http://Eaton.com).

**Eaton Adressen Worldwide:**

**Eaton.com**

**[www.eaton.eu/electrical/customersupport](http://www.eaton.eu/electrical/customersupport)**

**E-Mail: [automation@eaton.com](mailto:automation@eaton.com)**

**Internet: [Eaton.com/xv](http://Eaton.com/xv)**

**Eaton Industries GmbH**

Hein-Moeller-Str. 7-11  
D-53115 Bonn

© 2004 by Eaton Corporation  
Alle Rechte vorbehalten  
10/2020 MN04802004Z-EN



*Powering Business Worldwide*